

**GCO2-FC  
GCO2-FD**

**Contents**

<b>1. General product information</b> .....	<b>1</b>	8.1.2. Round ports (RSKG) .....	7
<b>2. List of acronyms and abbreviations</b> .....	<b>1</b>	8.2. Heat shrink .....	7
<b>3. Product images and dimensions</b> .....	<b>2</b>	8.2.1. Oval port .....	7
<b>4. Kit content</b> .....	<b>2</b>	8.2.2. Round ports.....	8
4.1. Kit content .....	2	<b>9. Fiber routing</b> .....	<b>9</b>
4.2. Elements from the FIST installation kit.....	2	9.1. FAS block routing.....	9
<b>5. Tools</b> .....	<b>2</b>	9.1.1. FAS block all cables - no restriction .....	9
<b>6. Installation of workstand/mounting bracket</b> .....	<b>2</b>	9.1.2. FAS block - microsheath restricted.....	9
<b>7. Cable preparation</b> .....	<b>2</b>	9.2. Prepare organizer.....	10
7.1. Cable diameter range .....	2	9.3. Fiber routing on the tray (SE/SC/SLE/Ribbon) .....	11
7.2. Feeder cable preparation .....	2	9.4. Splice protector.....	12
7.2.1. Remove jacket.....	2	9.4.1. SMOUV in SE tray.....	12
7.2.2. Prepare strength member.....	3	9.4.2. ANT in SE tray .....	12
7.2.3. Prepare tubes .....	3	9.4.3. SMOUV in SC tray .....	12
7.2.4. Bracket/ strength member and cable termination preparation.....	3	9.4.4. ANT in SC tray .....	12
7.2.5. Install cable assembly in enclosure .....	4	9.4.5. Ribbon 4/8 tray.....	13
7.2.6. Loop storage .....	5	9.4.6. Ribbon 12 tray.....	13
7.2.7. Routing to the tray .....	5	9.5. SHD (single high density) tray .....	13
7.3. Drop cable preparation.....	6	<b>10. Closing the enclosure</b> .....	<b>15</b>
<b>8. Cable sealing</b> .....	<b>7</b>	<b>11. Trade-marks</b> .....	<b>16</b>
8.1. Gel sealing.....	7	<b>12. Contact information</b> .....	<b>16</b>
8.1.1. Oval port (OSKG).....	7		

**1. General product information**

The CommScope FIST-GCO2-FX is an environmentally sealed fiber optic enclosure providing splicing and passive component integration in an outdoor fiber distribution network. The product can be configured for any requirement by adding splicing and/or passive devices. The FIST-GCO2-FX has provision for all cable termination and sealing requirements.

To clean FIST components, isopropyl alcohol is recommended.

The closure is a single-ended design made of a thermoplastic material.

The base and dome are sealed with latches and an O-ring system. One oval entry port for looped (uncut) cable management and six round ports for single cable entry/exit are included in the base. The cable seals are manufactured from heat-shrinkable or gel material.

The Universal Mounting System provides the foundation for mounting SOSAs and SASAs. The two sizes have each a standard capacity of 16 or 24 units. Different types of trays can be used in the groove plates (SE, SC, SLE, Ribbon and SHD trays).

Uncut loose buffer tube storage is available behind the UMS-profiles.

**2. List of acronyms and abbreviations**

FIST	Fiber Infrastructure System Technology	GCO2	Generic Closure Organiser
OSKG	Oval Seal Kit Gel	RSKG	Round Seal Kit Gel
FAS	Fiber Arrangement System	UMS	Universal Mounting System
SE	Single Element	SC	Single Circuit
SHD	Single High Density		
SOSA	Splice Only Sub Assembly	SASA	Splitter Array Sub Assembly

### 3. Product images and dimensions

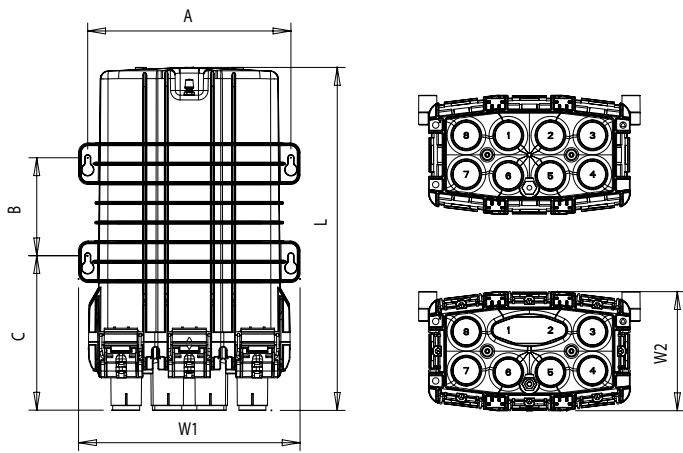

Product size	L (nom)	W1 (nom)	W2 (nom)	A (nom)	B (nom)	C (nom)
FIST-GCO2-FC	384	279	150	256	123	195
FIST-GCO2-FD	432	279	150	256	123	195

### 4. Kit contents

#### 4.1. Kit contents

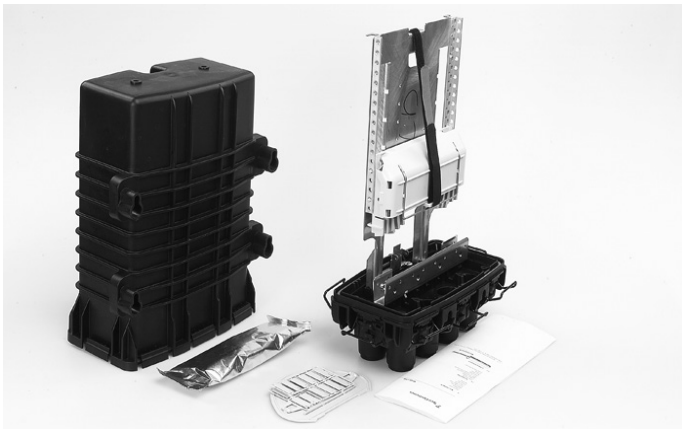

Depending on network layout and cable construction, kit contents received by the customer may differ from the kit contents described in this installation instruction.

- Dome
- Base including UMS, routing block and cover
- O-ring
- 1 tray cover, fiber guiding pin, tube holder retainers
- 1 tray wedge

Image for reference only.

#### 4.2. Elements from the FIST installation kit

Product name	UOM	QTY/ UOM	Product description
FISTV-E7185-3010	1 RL	50 m	Cut wire to open the FISTGCO2-F ports
FISTV-E7100-1005	1 PK	10x100g	Silicagel for inside the closure, to be replaced after each re-entry
FISTV-SPLI-COL	1 PK	30 sets	Split identifications collet (2-sizes) till 3.5mm

### 5. Tools

FIST-LCIT	Looped cable insertion tool for oval outlet	To insert loose tubes in oval port
FACC-TUBE-CUTTER-01	Tube cutter	To cut spiral tubing
FACC-AXIAL-STRIPPER-RC1	Tube stripper	To strip loose tubes
FACC-TUBE-STRIPPER-02	Tube splitter	To split buffer tubes 2.0-3.1mm
FACC-HEAT-GUN-220V	Heatgun + Heatgun tip	To shrink cable seals

### 6. Installation of workstand/ mounting bracket

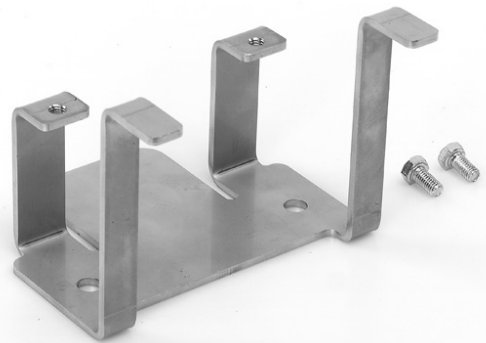

The FIST-GC02-F is mounted on a work stand. The work stand has a wrap-around design permitting to remove the enclosure with cables installed.

### 7. Cable preparation

#### 7.1. Cable diameter range

The cable diameter range in the 6 port base is as follows:

	Round port	Oval port
Loose tube	5-30 mm	12-25 mm
C.core	5-25 mm	12-25 mm

**Note:** When using gel (RSKG/OSKG kit) to seal the cable, the cable range can differ. Consult the dedicated RSKG/OSKG kit for the specific cable diameter range of the kit.

#### 7.2. Feeder cable preparation

##### 7.2.1. Remove jacket

Remove the jacket of the cable over the distance indicated in the table below:

Cable type	Enclosure type	Looped cable (window cut)	Drop cable
Loose Tube	FC	3.0 m	1.8 m
	FD	3.2 m	1.8 m

7.2.1.1. Cable without reverse oscillating point

Mark the cable in the middle and mark the cable on (1.5), (1.6) meters left and right of the first mark. Remove the cable jacket starting in the middle.

7.2.1.2. Reversed oscillating cable

Mark the cable in the middle of the loop and remove the cable jacket left and right of the mark over a total distance of 110cm (little more as the distance between two reversal points). Locate the buffer tube reversal point on the cable and mark the cable (1.5), (1.6) meters left and right from this point. Remove further the remaining cable jacket starting from this point.

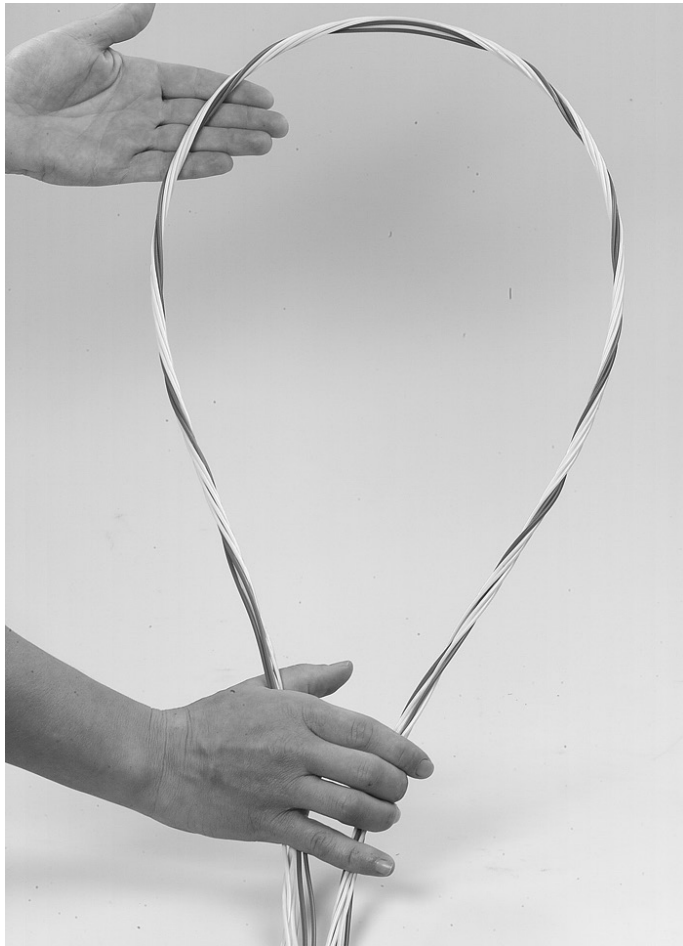

**Important:** make sure that the twist position of loose tube is identical on the left and right. This must be done correctly for ease of installation.

7.2.2. Prepare strength member

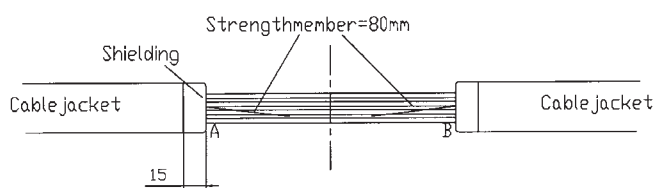
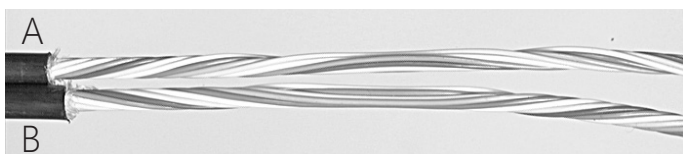

7.2.2.1. Remove the strength member leaving 80mm from the cable jacket, if shield is present leave 15mm of the shield.

7.2.3. Prepare tubes

7.2.3.1. Clean the loose tubes, remove all grease.

7.2.3.2. Identify the loose tubes with the split collet rings markers if applicable. There are different FIST-split-collet-rings depending on diameter of the loose tube.

7.2.4. Bracket/ strength member and cable termination preparation

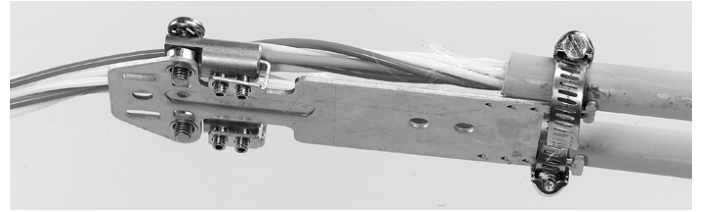

7.2.4.1. Insert the strength members of the cable into the universal strength member connector on the loop bracket (loosen the bolts with the Allen key if necessary) such that all loose tubes can be routed without unnecessary crossings. If installing a reversed oscillating cable, avoid twisting the loop. Secure with the Allen key.

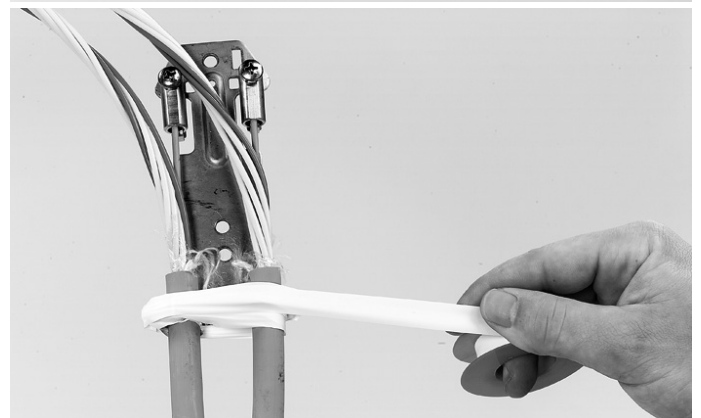
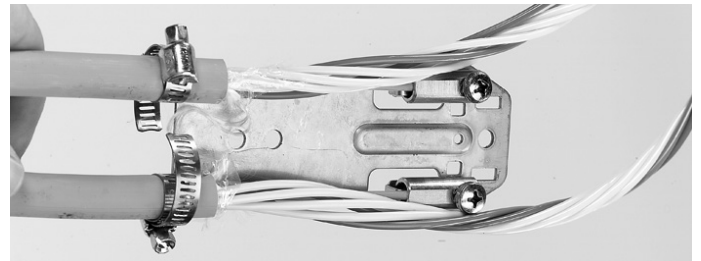

7.2.4.2. If the cable diameter is **more than 8mm** secure the cables with the hose clamp onto the loop bracket. Wrap a few layers of tape around the hose clamp to protect the heatshrink.

**Note:** Bend the sharp edges of the hose clamp towards the cable.

7.2.4.3. If the cable diameter is **less than 8mm** secure the cables with tie wraps. Cut the excess strap and apply a few layers of tape around the tie wrap and cable to protect the heatshrink.

## 7.2.5. Install cable assembly in enclosure

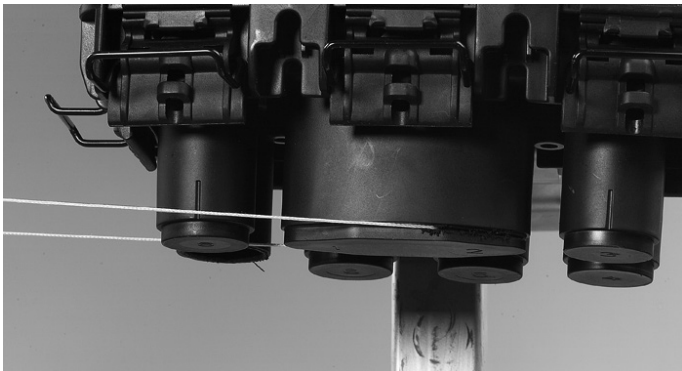

7.2.5.1. Open the oval port; the cutting wire can be used.



**7.2.5.2. If sealing with heatshrink:** Push the loose tubes through the oval sleeve. The non-coated edge of the sleeve (arrow) should be pointed towards the base of the closure. Make sure the hotmelt in the sleeve is protected against dirt. The plastic bag of the packaging can be used to protect it.



7.2.5.3. Push the loose tubes through the oval port. The LCIT can be used to avoid kinking of the loose tubes.

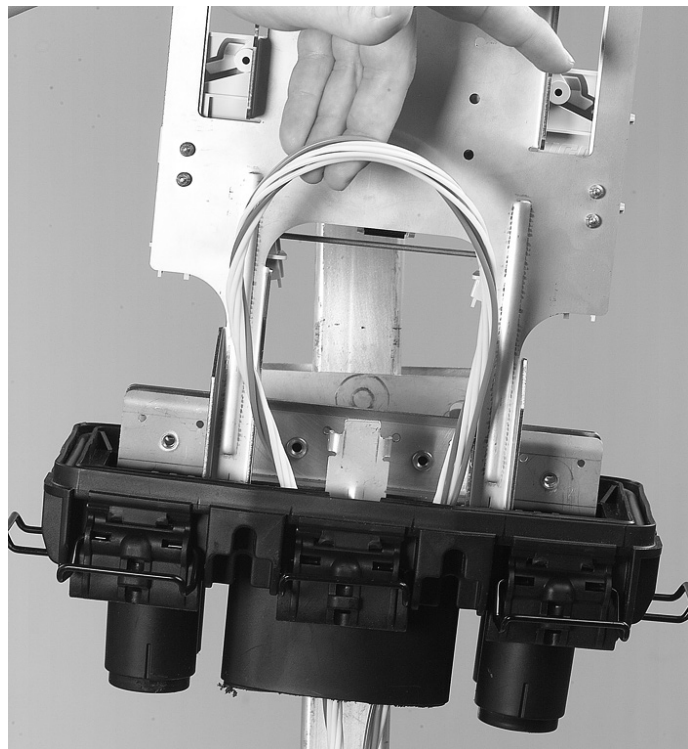

7.2.5.4. Remove the LCIT (if used) and pull the cable gently into the closure.

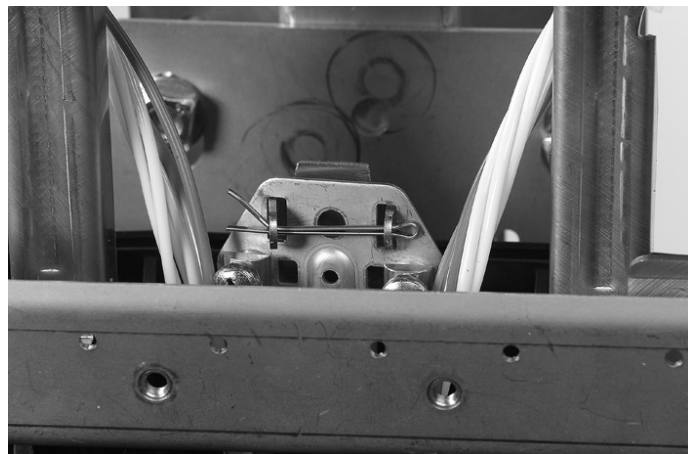

7.2.5.5. Secure the bracket with the split pen.

7.2.5.6. Seal the cable (gel or heatshrink, see chapter 8).

## 7.2.6. Loop storage

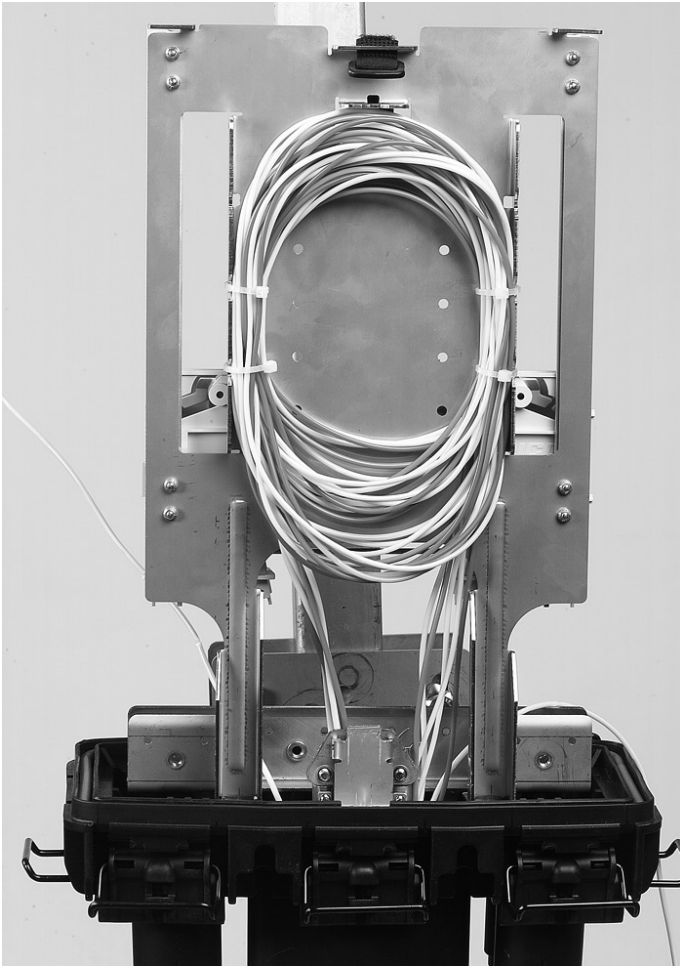

7.2.6.1. Loop the uncut loose tubes within the dedicated area; secure with tie wraps.

**Note:** For microsheath tubes: loosely secure the loop. Make sure the loop is also secured to the top of the bracket and to the 2 top positions of the sides. This to make sure the loop is properly contained within the bracket.

## 7.2.7. Routing to the tray

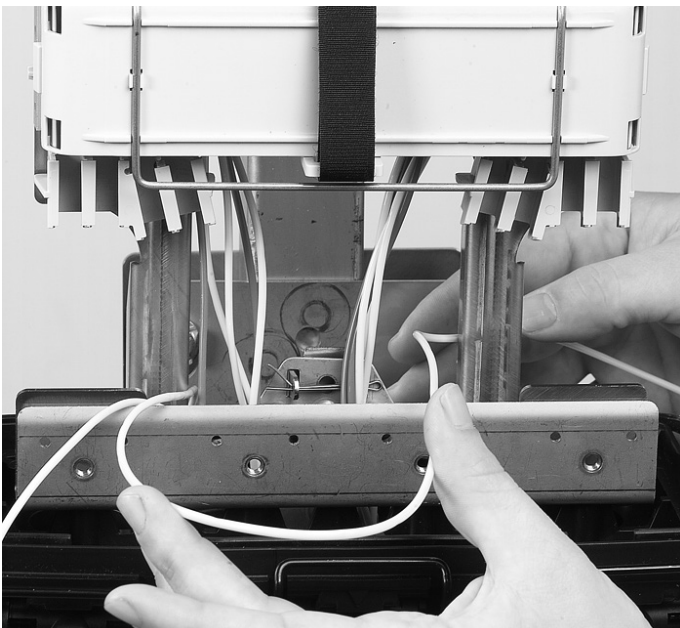

7.2.7.1. Select the loose tube(s) with the fibers that have to be spliced.

**Note:** Tubes routed up to the tube holder should be routed in a way providing complete access to the stored tubes in the dedicated area. Access is needed for later routing of loose tubes from the loops to the tube holders, without creating crossings and without creating disturbances on the loose tubes already routed up to the tube holders.



7.2.7.2. Match the tube(s) in the tube holder and mark the tube between the two marks on the tube holder.

**Note:** If microsheath restricted FAS block is used, follow instructions as described in paragraph 9.1.2. Mark on the tube is on a different location in the FAS block.



7.2.7.3. Remove the sheath of the tube with appropriate tooling until or between the marks of the tube, per standard practice.

**Note:** If shaving the tube, separate the fiber loops till the tube holder and make sure they are 'twist free' before to route them to the tray(s).

**Note:** If the fibers are not 'twist-free', separate out the fiber(s) that are to be spliced, and cut these fibers in the middle of the loop. Remove these fibers from the bundle up to the tube holder.

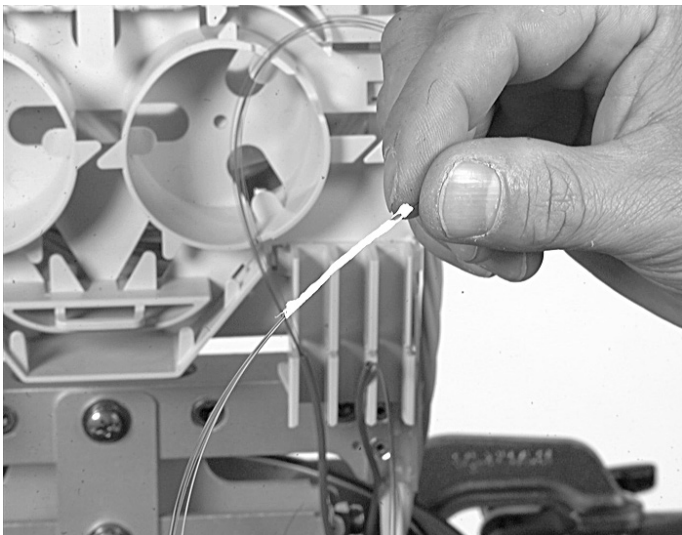

7.2.7.4. Clean the fibers and wind some PTFE tape around the ends of the tubes and fibers to protect the transition from tube to fibers.



7.2.7.5. Slide the tube holder retainer in with the snap upwards. Start with the bottom cavity of the tube holder to store the first loose tube and place the tube holder retainer just above it in the groove. The tube holder retainer must snap.

**Note:** Identify exchange and customer-side using some PTFE tape around the fibers. One can also use the FIST-splitcollets-rings markers to identify the loose tubes.

7.2.7.6. Continue with chapter 9.3 explaining the fiber routing to the tray and fiber storage on the tray.

### 7.3. Drop cable preparation

7.3.1. Remove the cable jacket for 1.8m. The length is applicable for both enclosure types, FC and FD.

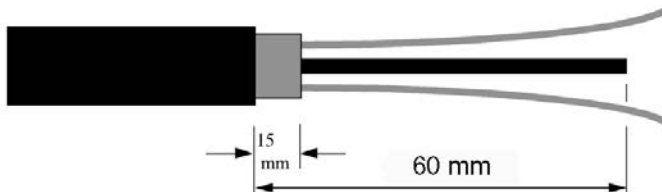

7.3.2. Remove the strength member leaving 60mm from the cable jacket, if a shield present leave 15mm of the shield.

7.3.3. Open the round port; the cutting wire can be used. Select the port such that a minimum of fibers or tubes are crossed. Start using ports 3 or 8.

7.3.4. **If sealing with heatshrink:** Push the loose tubes through the sleeve. The non-coated edge of the sleeve (arrow) should be pointed towards the base of the closure. Make sure the hotmelt in the sleeve is protected against dirt. The plastic bag of the packaging can be used to protect it. (See installation heatshrink, chapter 8.2).

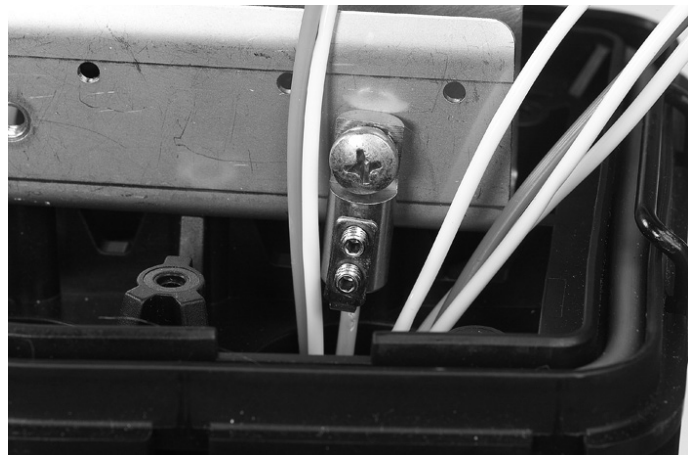

7.3.5. Install the strength member connector on the strength member before entering the cable into the enclosure. Push the tubes and connector through the port and secure the strength member connector on the metal bracket as shown.

Be sure that all loose tubes are routed without crossings around the strength member.



7.3.6. Match the loose tube on the tube holder, mark and strip the loose tube from this mark. Clean the fibers.

**Note:** If *microsheath restricted FAS block* is used, follow instructions as described in paragraph 9.1.2. Mark on the tube is on a different location in the FAS block.



7.3.7. Tear off a tube holder retainer.

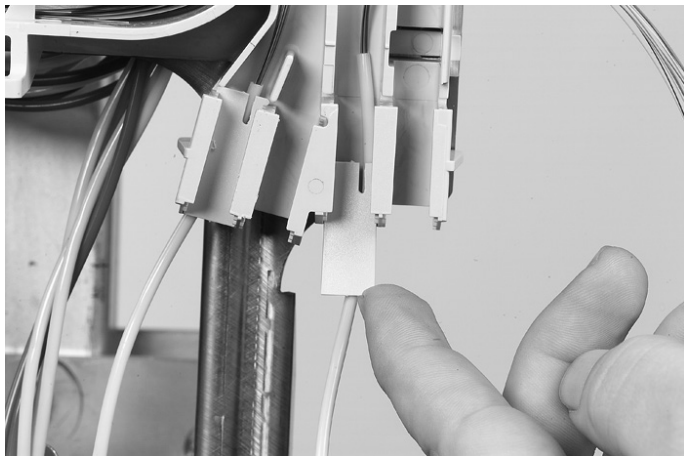

7.3.8. Position one or more loose tubes in the tubeholder in the correct position as shown. Slide the tube holder retainer in with the snap upwards. Start always with the bottom cavity of the tube holder and place the tube holder retainer just above it in the groove. The tube holder retainer must snap.

7.3.9. Continue with chapter 9.3 explaining the fiber routing to the tray and fiber storage on the tray.

## 8. Cable sealing

The GCO2-FX enclosure can be used with gel sealing or with heatshrink sealing.

### 8.1. Gel sealing

#### 8.1.1. Oval port (OSKG)

To seal the oval port with gel, use the Oval Seal Kit gel (OSKG) and following the installation instruction delivered with the kit to install the oval gel seal.

#### 8.1.2. Round ports (RSKG)

Gel seal kits for the round ports are available with different amounts of cables per port. Use the appropriate Round Seal Kit Gel (RSKG) and following the installation instruction delivered with the kit to install the round gel seal.

Start using ports 3 or 8.

## 8.2. Heatshrink

### 8.2.1. Oval port

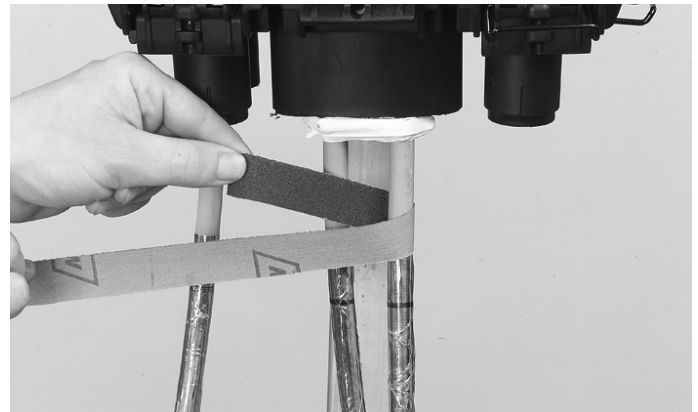
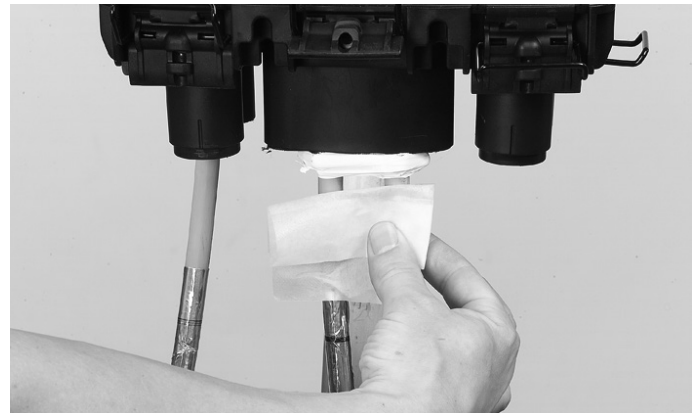

8.2.1.1. Clean by using the cleaning tissue. First clean and then abrade port and cable.

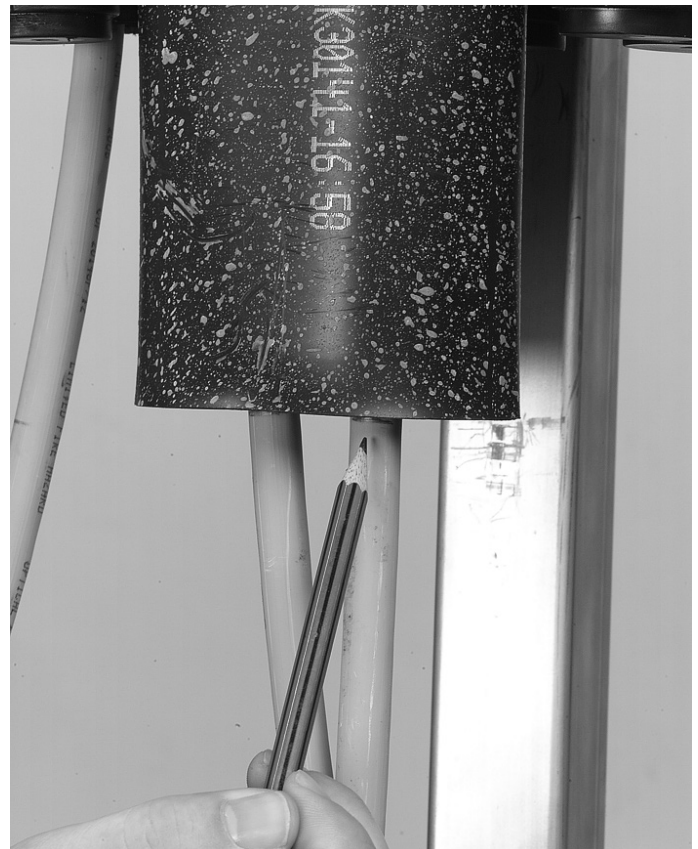

8.2.1.2. Remove the packing bag (used to protect the hot-melt against dirt) from the sleeve, push the sleeve upwards to the base and mark the cable flush with the sleeve. Make sure the non-coated zone butts up against the base.

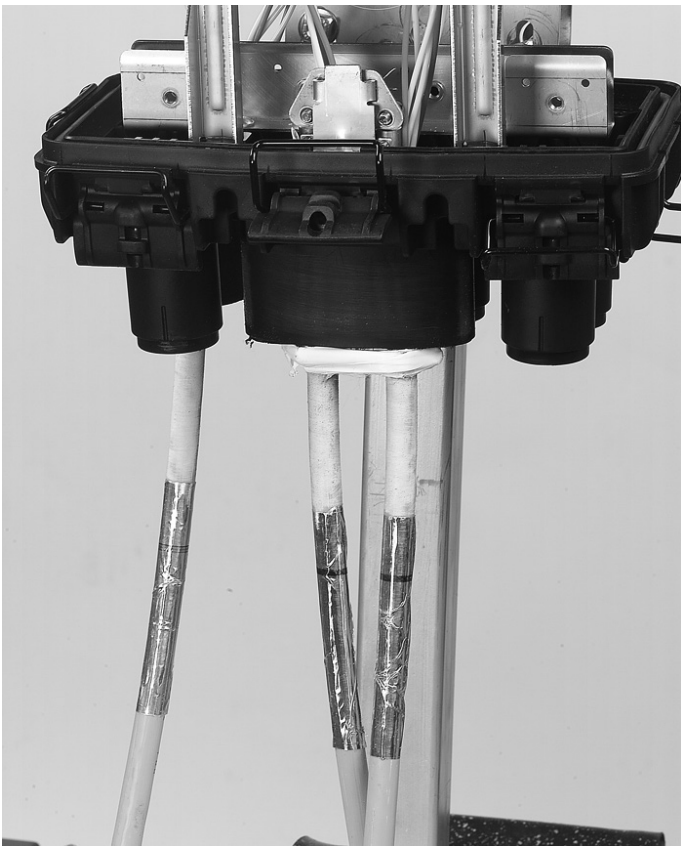

8.2.1.3. Match the blue line of the aluminium protection foil with the marks on the cables. Wrap the aluminium cable protection foil around the cable.

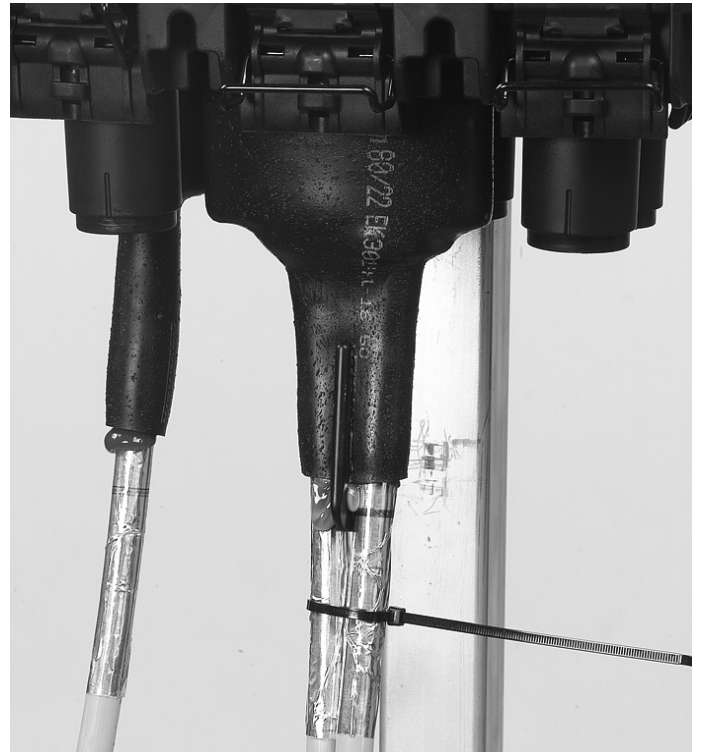

8.2.1.5. Start heating the sleeve on the base, and wait one minute and shrink in spiral movements downwards. Hold the cable in position. Shrink until the green painting dots become black, and the hotmelt is visible on the end of the sleeve. Postheat the clip on both sides till the adhesive shows a proper flow.

**Do not move the FIST-GCO2-F or cable for 20 minutes.**

## 8.2.2. Round ports

8.2.2.1. Start using ports 3 or 8.



8.2.1.4. Push the sleeve against the base and install the clip.

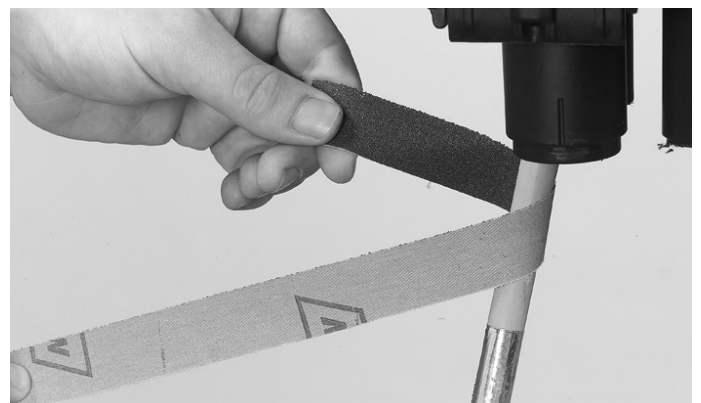
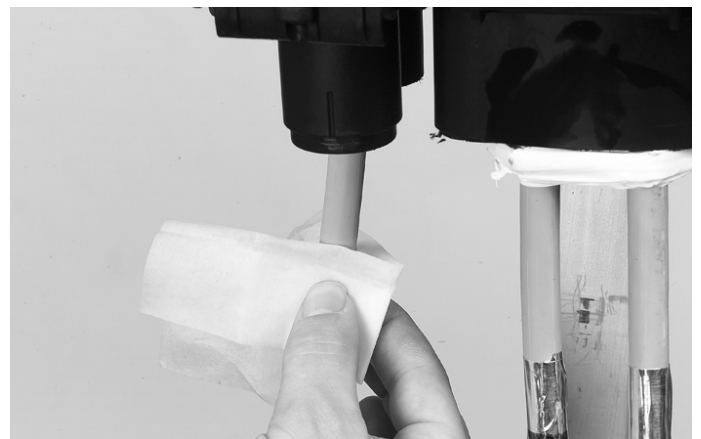

8.2.2.2. Clean by using the cleaning tissue. First clean and then abrade port and cable.





8.2.2.3. Mark the cable with the end of the sleeve. Make sure the sleeve butts up against the base.



8.2.2.4. Drop cable sleeve installed.

## 9. Fiber routing

### 9.1. FAS block routing

#### 9.1.1. FAS block all cables - no restriction

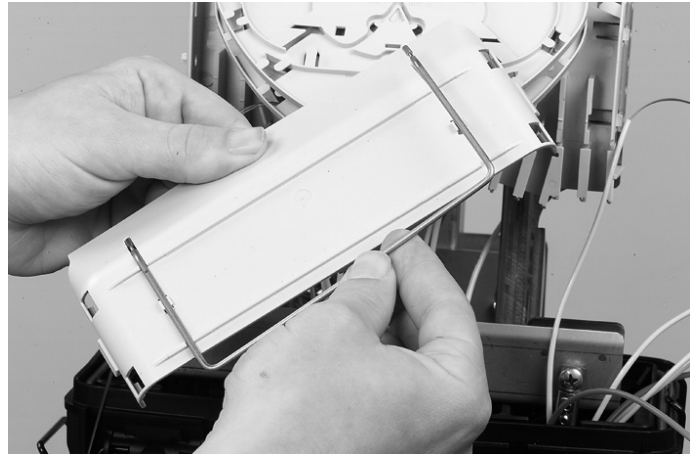

9.1.1.1. Remove the strap and the routing block cap. To remove the routing block cap, lift the two snaps on one side of the routing block cap.

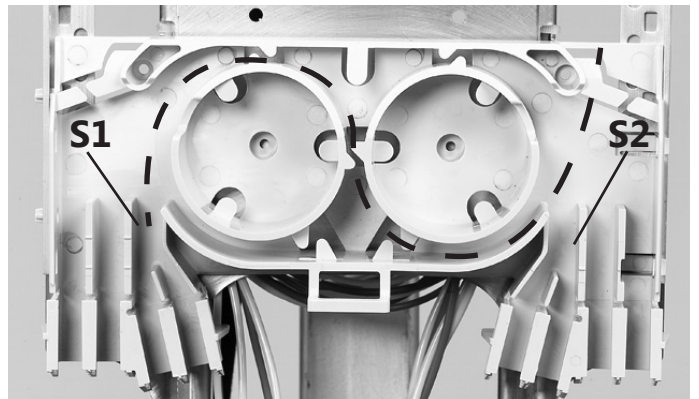

9.1.1.2. Fibers can be routed between S1, S2, over the drums as shown. Select the cable termination such that a minimum of fibers or tubes will cross.

#### 9.1.2. FAS block - microsheat restricted

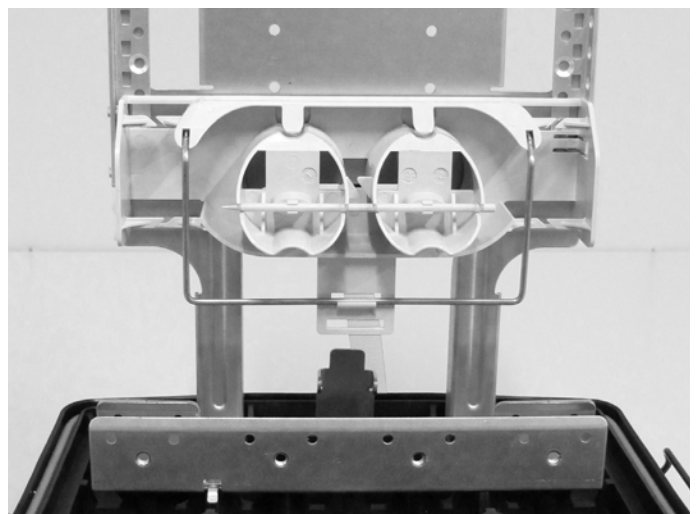

9.1.2.1. The FAS block for the microsheat restricted cables uses less UMS positions and has no routing block cap. Fiber guidance pin as well as the wedge can be retrieved directly attached to the FAS block.

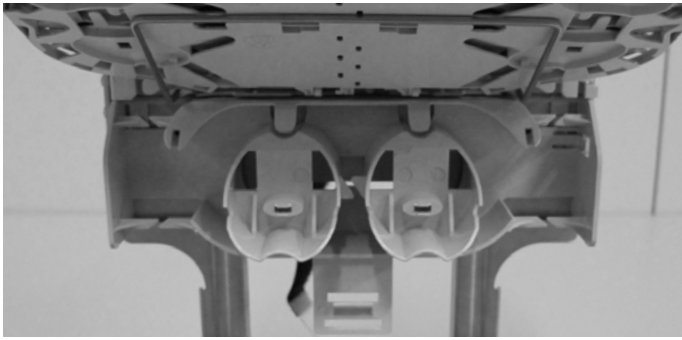

9.1.2.2. If trays are installed: mount the wedge in the two holes under the tray in the wraparound groove plate as shown in picture above. (To remove the wedge, take care it is removed out of the two holes simultaneous.)

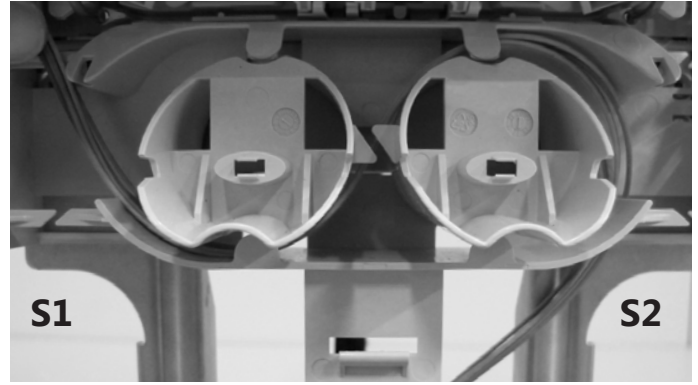

9.1.2.5. The microsheat tubes can be routed from S1 to S2 over the drums of the FAS block as shown. Jacket of the tubes remains on the tubes during this routing.

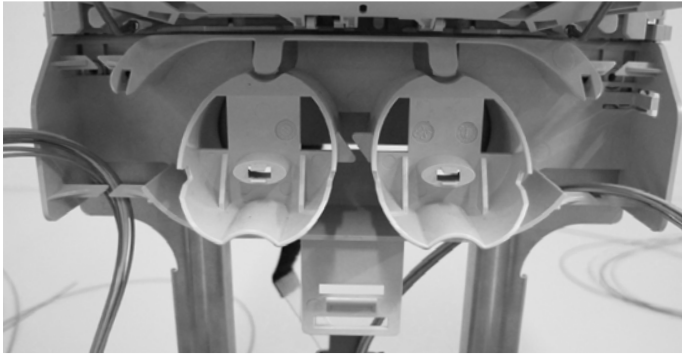

9.1.2.3. Route the microsheat tubes to the FAS block.

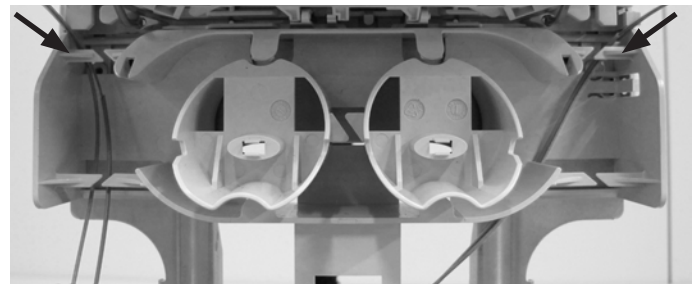

9.1.2.6. Before the fibers enter the groove plate, the microsheath should be removed up to the point indicated with an arrow on the image above (it indicates the rib on top of the last lip on the microsheat only FAS block). Only 250µ fiber (primary coated) enters the tray.

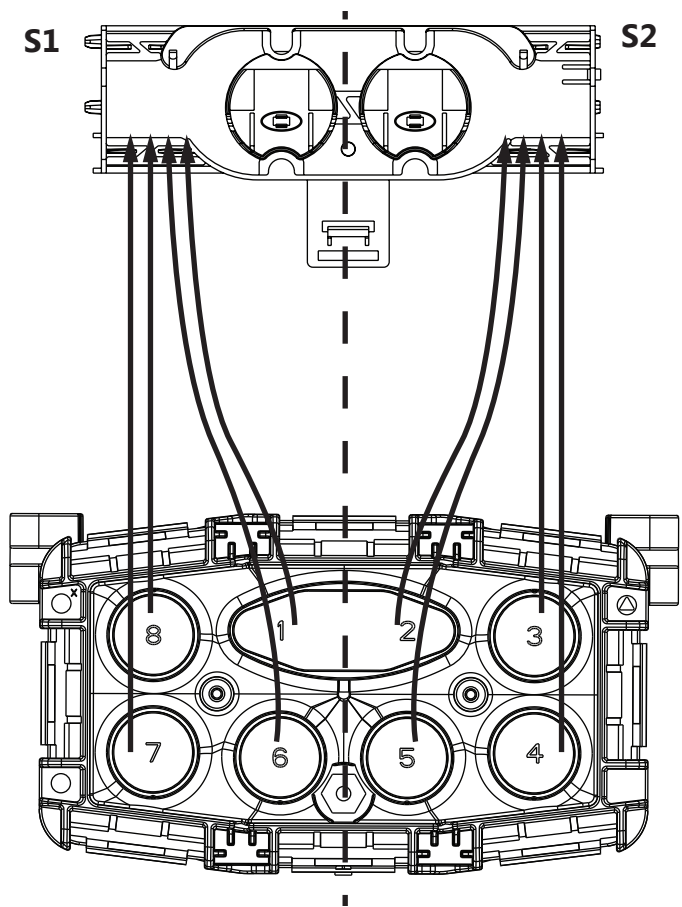

9.1.2.4. CommScope recommends routing the fibers to the side where the cable enters the closure to avoid crossings below the FAS block.

## 9.2. Prepare organizer



9.2.1. Secure the wraparound groove plate on the UMS by putting the plate with the long protrusions in the S1 UMS-profile and sliding the plate in the S2 UMS-profile until it snaps. (Do not leave gaps between groove plates.)

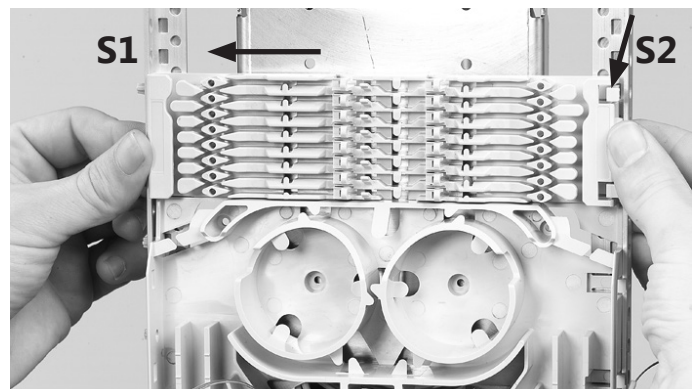

9.2.2. To remove the groove plate, push the two snap-fits at the S2 UMS-profile and slide the wraparound plate towards the S1 UMS-profile.

### 9.3. Fiber routing on the tray (SE/SC/SLE/Ribbon)

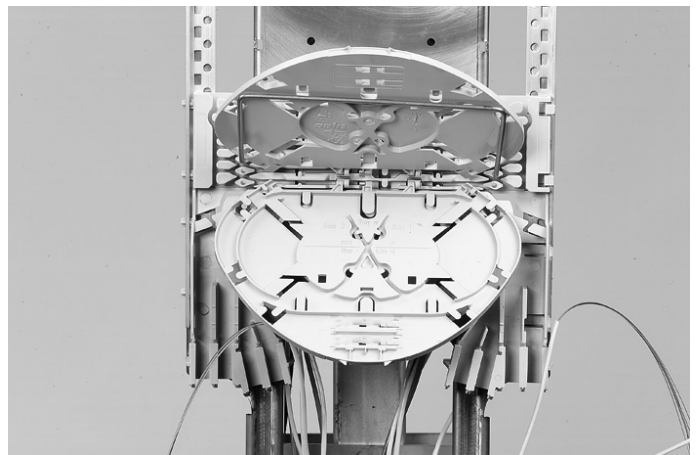
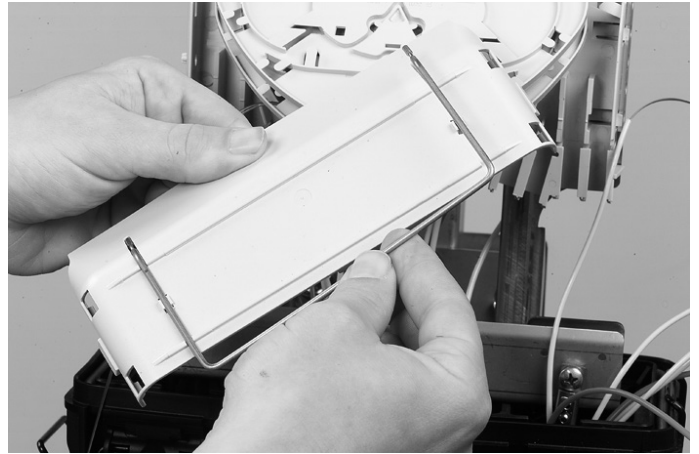

9.3.1. Identify the tray to be worked on and make it accessible. If the routing block and trays are in vertical position, you will have to support the trays above the selected one using the tray wedge which fits in the holes of the wraparound groove plate. Position the wedge carefully such that the groove is still accessible for the fibers and be careful not to push the wedge against fibers. (To remove the wedge, take care it is removed out of the two holes simultaneously.)

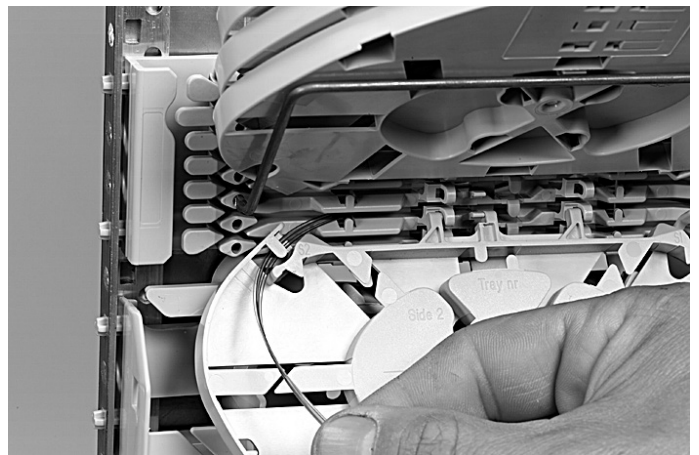

9.3.2. Route the fiber in the grooves of the wraparound groove plates to the entrance of the identified tray.

**Note:** Fiber must be routed in the groove underneath the hinge of the tray!



9.2.3. Place a tray in the wraparound groove plate; do this by pushing the lip on the groove plate (lowest possible position) slightly down with the tray. Move the tray lateral into the hinge-cavities of the groove plate.

To snap the SE tray in the W/a single fiber groove plate leave one hinge facility open between FAS block or previous tray and the SE-tray (this tray is thicker than the SC tray and uses 2 units (hinge positions) on the groove plate instead of 1).



9.2.4. To remove the tray: put the fiber guiding pin between lip on wraparound groove plate and tray, and move lateral towards S1.

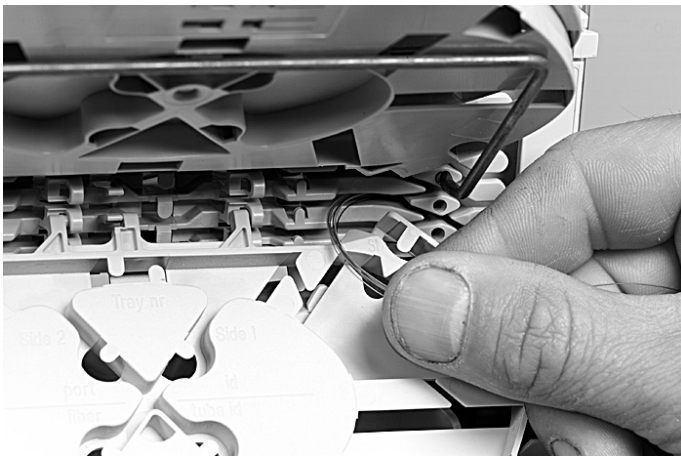

9.3.3. Pull gently on the fibers in the tray and make sure that the fibers are well contained in the routing block and wraparound groove plate.

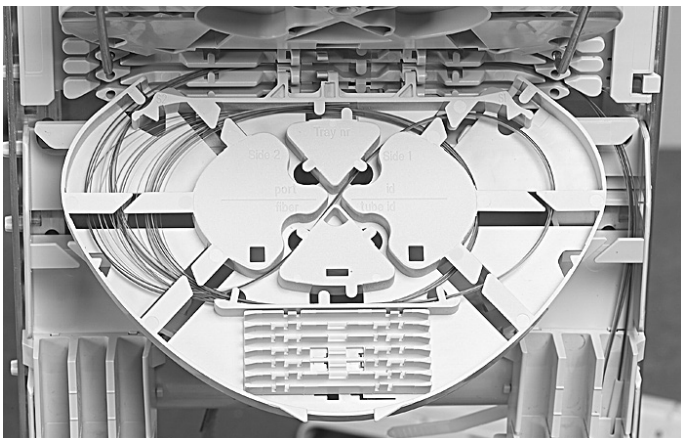

9.3.4. Store the fibers temporarily on a tray (picture shows an example of a loopback).

9.3.5. Storing dark fibers can be done in different ways:

1. Organize dark fibers into the different trays.
2. Organize dark fibers together into the first available tray (i.e. with a max. of 24 cut or 12 looped primary coated fibers in one SE-tray).

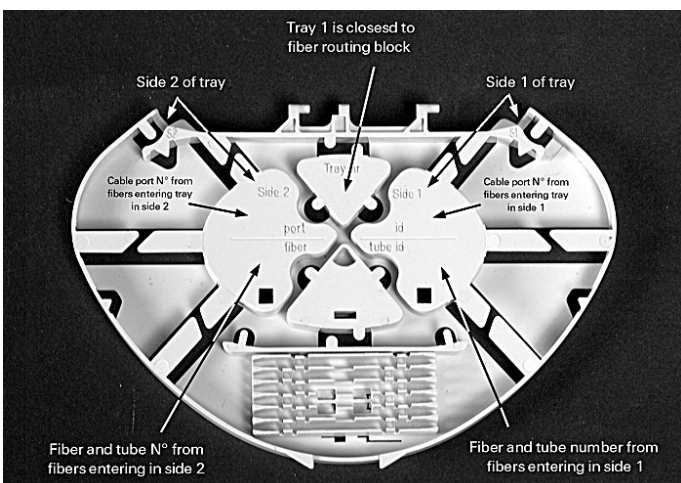

9.3.6. Routing on the tray is the same for the four types (SC, SE, SLE, Ribbon). Fiber and tube numbering can be done with a permanent marker in the areas as indicated on the image above

9.3.7. Splice per standard practice and store the splice protector centered in the splice holder.

## 9.4. Splice protector

Different splice protectors are available for the different trays, sections below show the different possibilities:

### 9.4.1. SMOUV in SE tray

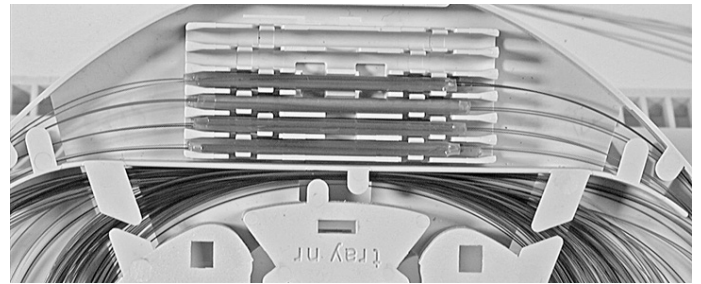

### 9.4.2. ANT in SE tray

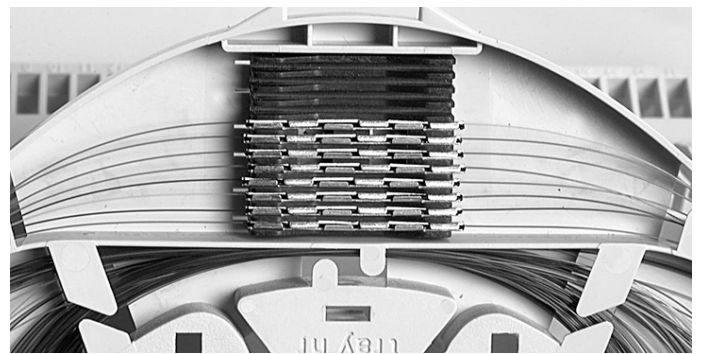

### 9.4.3. SMOUV in SC tray

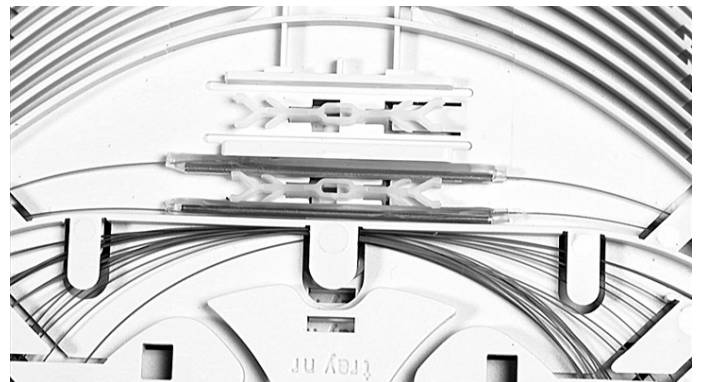

### 9.4.4. ANT in SC tray



### 9.4.5. Ribbon 4/8 tray

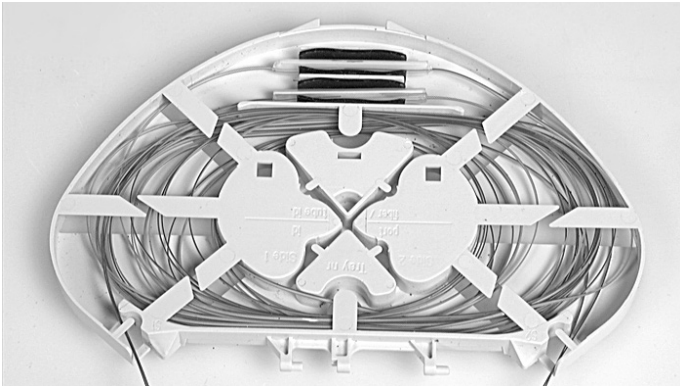

### 9.4.6. Ribbon 12 tray

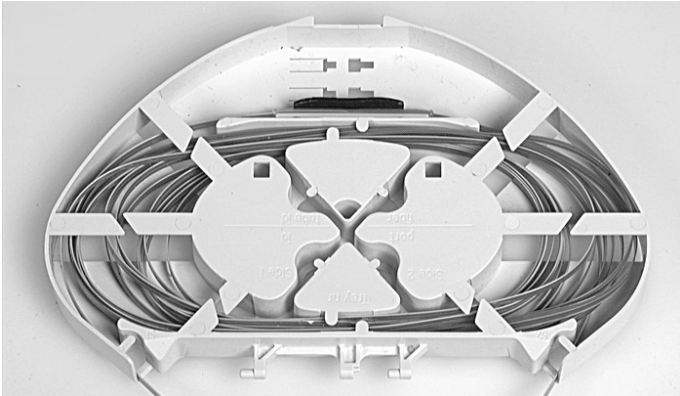

## 9.5. SHD (single high density) tray

The SHD tray has a different layout (see image below) than the SC/SE/SLE and Ribbon tray.

The tray has the same thickness as the SC/SLE trays and also needs only 1 unit (hinge position) on the wrap around groove plates.

24 splices can be stored on the tray, using SMOUV 45 splice protector. Always use area 1 first to store the SMOUV 45.

The entrance duct of each side of the tray is limited to 24 fibers.

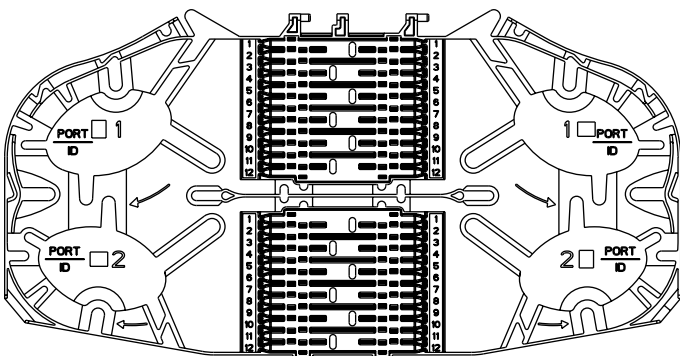

Follow installation guidelines to route the fibers correctly in the tray:



9.5.1. Route the fibers in the groove plates until the selected tray.



9.5.2. Make the selected tray accessible with the wedge and route the fibers through the groove to the entrance of the tray.

**Note:** the maximum amount of fibers at the entrance of the tray is 24 fibers.

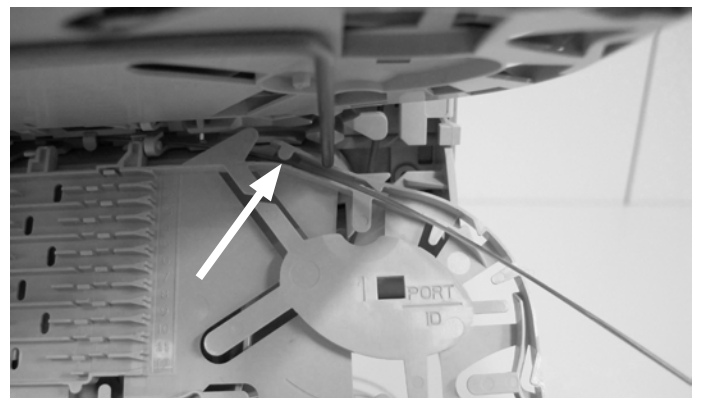

9.5.3. Measure the remaining length of the fibers from the first lip on the tray (see arrow on image above). Ideal remaining length of the fibers on the tray is 1m.

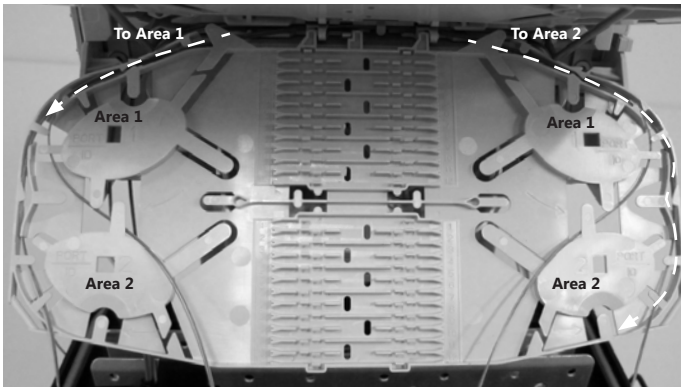

9.5.4. 12 fibers are routed to area 1, the next 12 fibers are routed via the small duct to area 2.

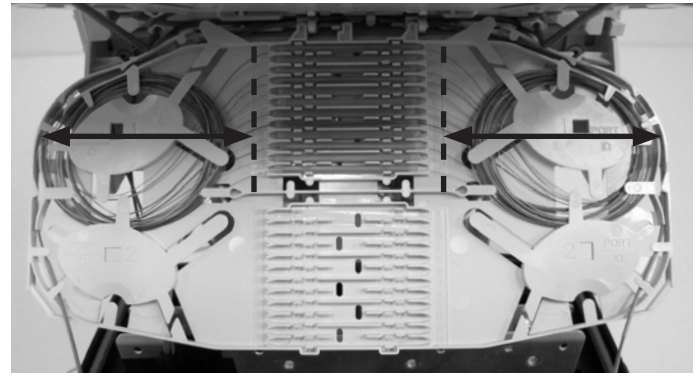

9.5.8. Make loops with a diameter of circa 60mm and install the loops under the lips of the tray as shown. The loops may not pass the line next to the splice protector numbering (see indication on picture above).

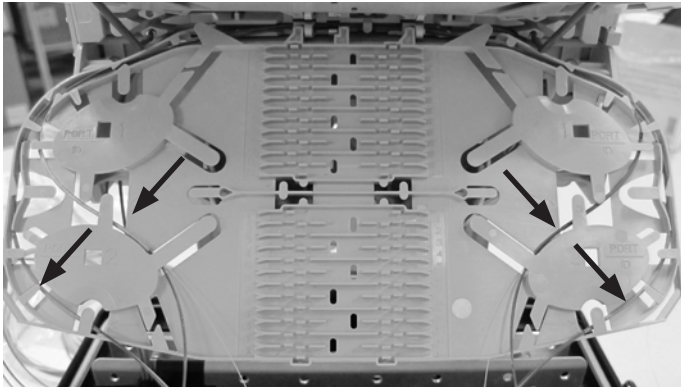

9.5.5. If required, a piece of the jacket can be used to indicate the bundle of fibers.



9.5.9. Wrong installation of loops around the island. Loops are passing the line and are too close to the splice holder.



9.5.6. Always start with splicing the fibers of area 1. Make fusion splice per standard practice and push the splice protector (SMOUV 45) in the splice holders starting with position 1 (top position). Install the fibers in the correct color code sequence if required.

**Note:** the splice holders in the SHD tray are limited to the use of SMOUV 45.

**Note:** When storing over-length fibers, observe the following general rules:

1. The fibers may not be routed too tight around the island.
2. Make sure all fibers are properly positioned under the lips.



9.5.7. To store over-length around the islands, start the routing following the arrow (which is also indicated on the tray).

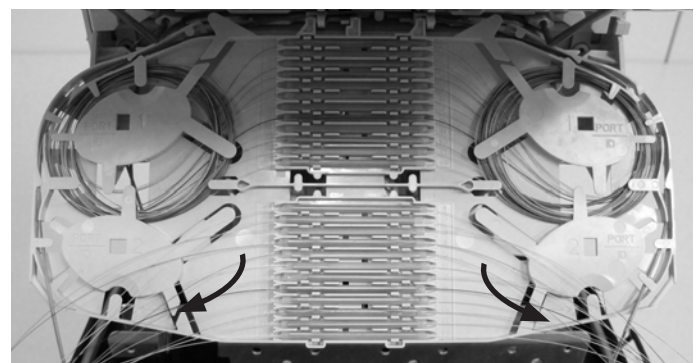

9.5.10. Make fusion splice for fibers routed to area 2 and push the splice protector (SMOUV 45) in the splice holders starting with position 1 (top position). Install the fibers in the correct color code sequence if required.

## 10. Closing the enclosure



9.5.11. Make loops with a diameter of circa 60mm and install the loops under the lips of the tray as shown. The loops may not pass the line next to the splice protector numbering (see indication on picture above).

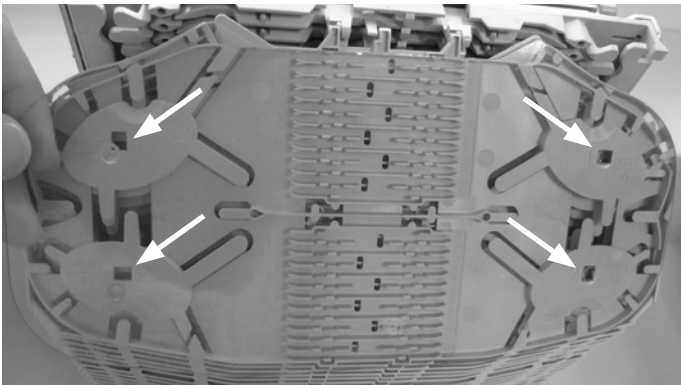

9.5.12. Install the top cover on the upper tray. Push the 4 protrusions into the holes of the tray.

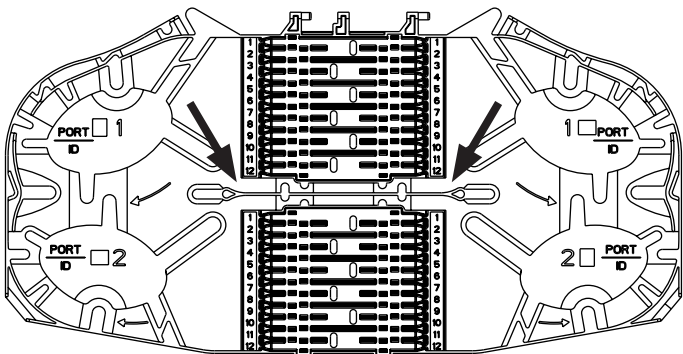

9.5.13. Note: the 2 grooves in the middle can be used to make a crossings on the tray: if the fibers need to be spliced enters the tray from the same side, one fiber can make a u-turn on the tray using these grooves (indicated by the 2 arrows on the image above).

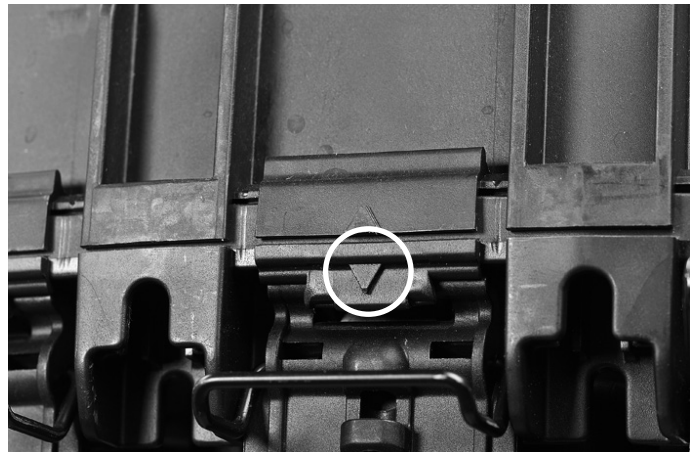

10.1. Remove the outer bag and place the silicagel in the closure. Check that all latches are in an open position. Place the O-ring back on a clean base and place the dome on top of it. Check whether the triangles of dome/base match.

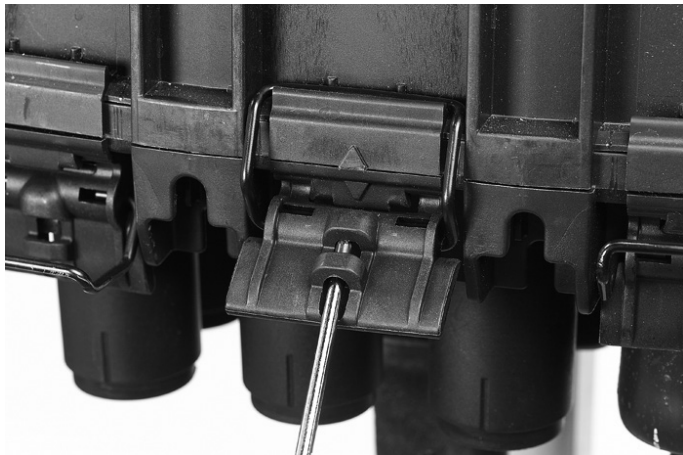
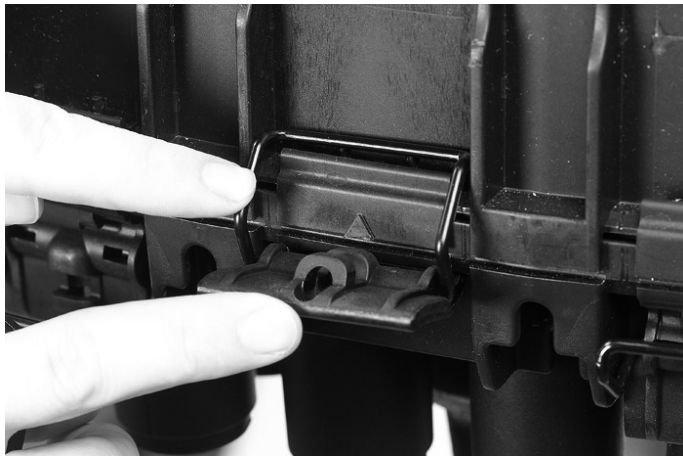

10.2. Closing the latches with a screwdriver.

## 11. Trade-marks

All trademarks identified by ® or ™ are registered trademarks or trademarks, respectively, of CommScope, Inc. This document is for planning purposes only and is not intended to modify or supplement any specifications or warranties relating to CommScope products or services. CommScope is committed to the highest standards of business integrity and environmental sustainability, with a number of CommScope's facilities across the globe certified in accordance with international standards, including ISO 9001, TL 9000, and ISO 14001.

Further information regarding CommScope's commitment can be found at [www.commscope.com/About-Us/Corporate-Responsibility-and-Sustainability](http://www.commscope.com/About-Us/Corporate-Responsibility-and-Sustainability).

## 12. Contact information

Visit our website or contact your local CommScope representative for more information.

For technical assistance, customer service, or to report any missing/damaged parts, visit us at: <http://www.commscope.com/SupportCenter>

This product is covered by one or more U.S. patents or their foreign equivalents. For patents, see [www.commscope.com/ProductPatent/ProductPatent.aspx](http://www.commscope.com/ProductPatent/ProductPatent.aspx)