

NG4access ODF Platform

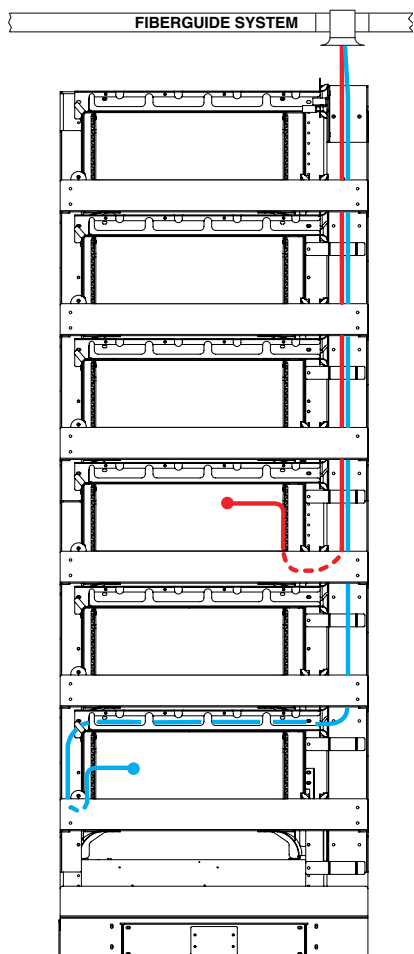

25085-A

Table of Contents

- IFC From Overhead..... 2
- IFC From Under Floor 3
- FOT Patch Cord From Overhead (No FOTSP)..... 4
- FOT Patch Cord From Overhead (With FOTSP)..... 5
- OSP/IFC to Splice Chassis to Splice Chassis..... 6
- Installing Adapter Packs on Rear of Chassis..... 7
- Installing an IFC Module, VAM or MPO-Module Into Access Tray..... 8
- Installing a Cabled Module 9
- Routing Cables Through Access Tray..... 10

Technical Assistance

<http://www.commscope.com/SupportCenter>

IFC From Overhead

Clamp cable at top right of frame (A). Route cable sub-unit through outer channel (B). Form drip loop (C). If terminating cable on right side of frame, route cable through trumpet flare (D) to chassis. If on left side, route cable through crossframe trough (E) and around radius limiter (F) to chassis. Snap cabled module into tray (see pages 9-10).

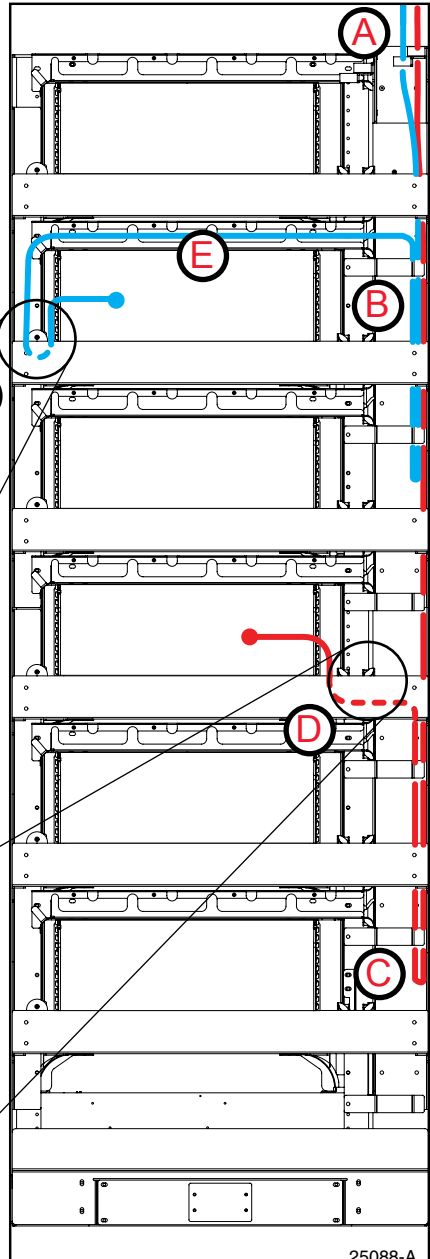
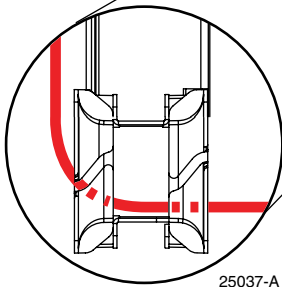
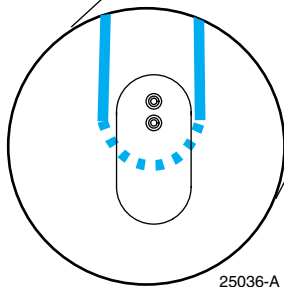

IFC From Under Floor

Clamp cable at bottom right of frame (A). Route cable sub-unit through outer channel (B). If terminating cable on right side of frame, route cable through trumpet flare (C) and snap cabled module into tray (see pages 9-10). Take up slack on appropriate spool* (D). (*Spool kit must be ordered separately.) If on left side, route cable through crossframe trough (E), around radius limiter (F), and snap cabled module into tray (see pages 9-10). Take up slack on highest spool within reach (G).

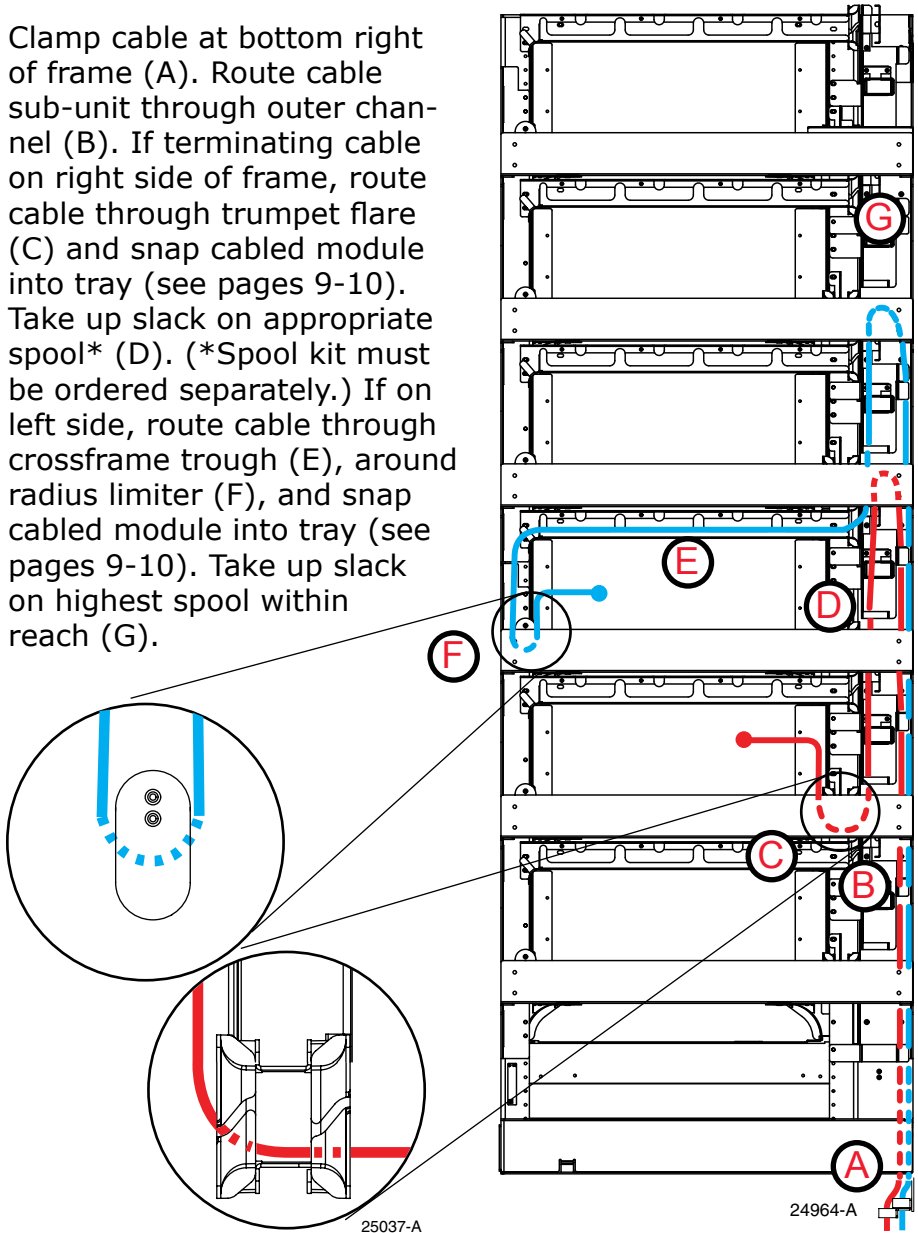

25037-A

24964-A

FOT Patch Cord From Overhead (With No FOTSP)

Route patch cord from FiberGuide at top right of frame (A). Route through inner channel (B). If terminating cable on right side of frame, route cable through trumpet flare (C) to chassis. If on left side, route cable through crossframe trough (D), around radius limiter (E), and into chassis. Plug connector into designated adapter port (see pages 9-10).

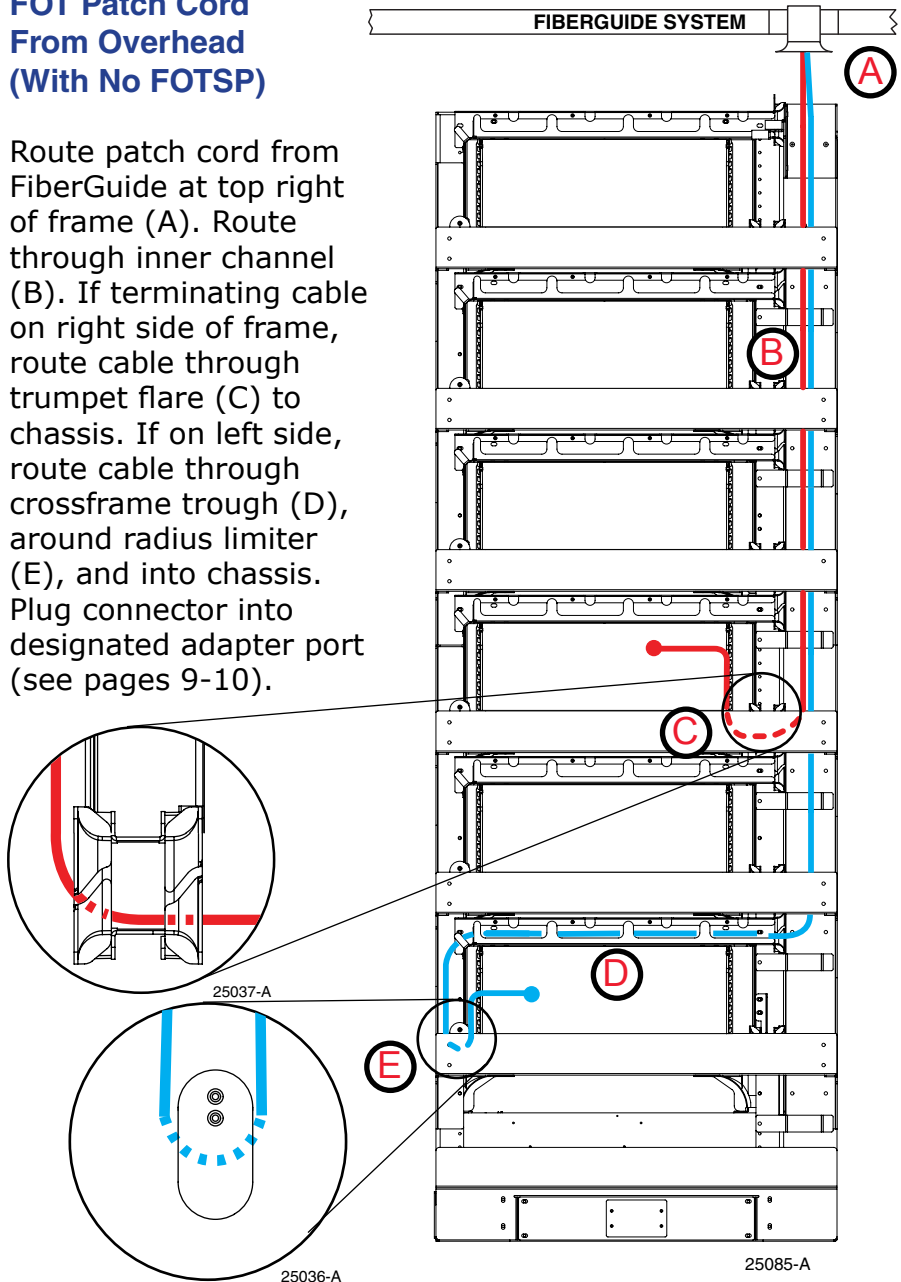

FOT Patch Cord From Overhead (With FOTSP)

Route patch cord from FiberGuide into FOTSP channel (A). Route down FOTSP channel (B). If terminating cable on right side of chassis, route cable through trumpet flare (C) to chassis. If on left side, route cable through crossframe trough (D), around radius limiter and into chassis (E). Plug connector into adapter port (see pages 9-10). Hang slack over FOTSP spool (F).

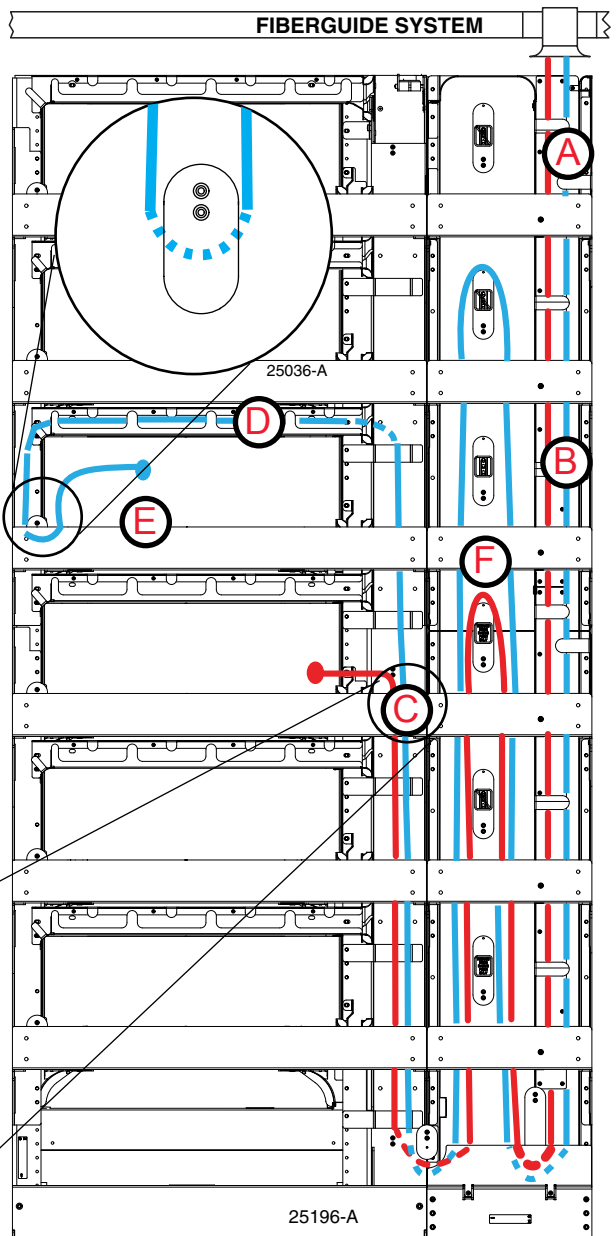
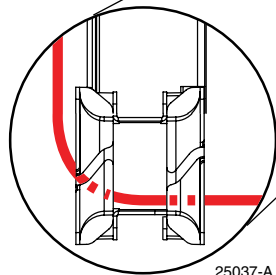

OSP/IFC to Splice Chassis

For overhead applications, clamp cable at top right of frame (A) using standard clamp. For underfloor applications, clamp cable at bottom right using underfloor clamp (B). Route through outer channel (C) around spool (D), and to area below splice chassis (E); refer to TECP-90-704.

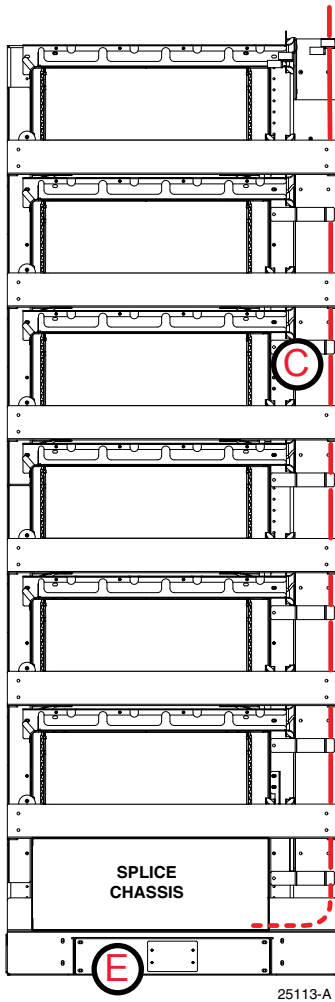

Overhead Application

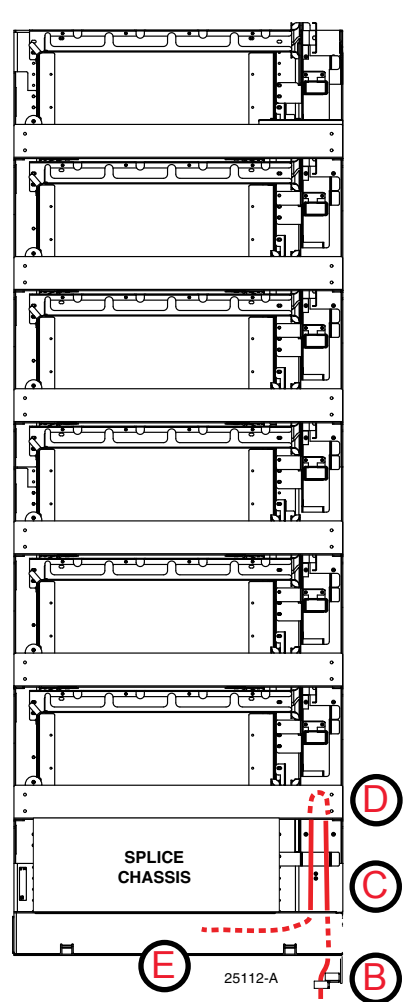

Underfloor Application

Pigtail Cabled Module to Splice Chassis

If installing pigtail cabled module on right side of frame (A), route cable through trumpet flare (B) and down through inner channel (C) to area below splice chassis (D). If on left side (E), route cable down and around radius limiter (F), through crossframe trough (G), and then through inner channel (C) to area below splice chassis (D). For instructions on installing module, see pages 9-10.

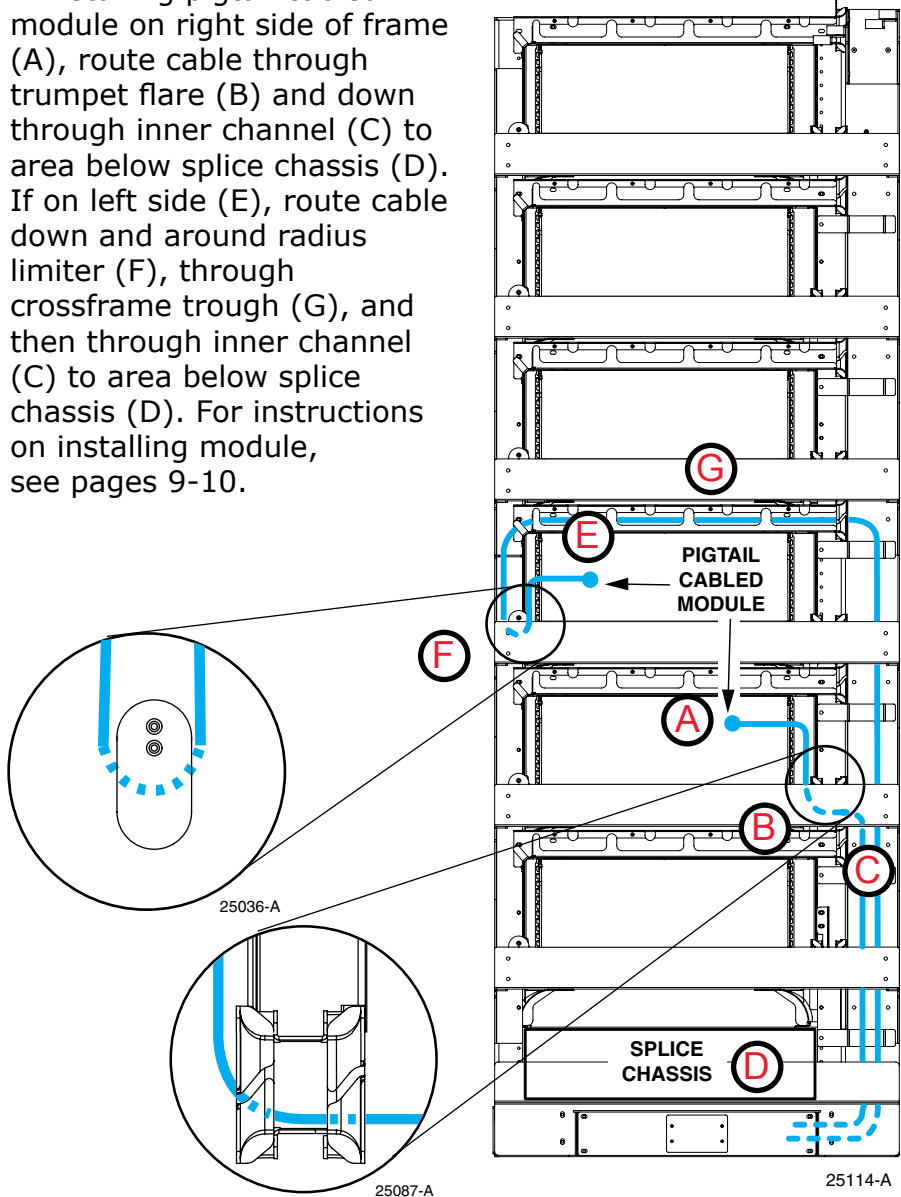

Installing Adapter Packs

Adapter packs can be installed from either front or rear of the chassis. If installing from the rear: Pull out the access tray handle (A) to access the tray. Position the adapter pack tabs on the access tray slots in locations (B), (C), and D). Press the tabs into the slots until a definite click is heard or felt. Push in access tray handle to close the access tray.

NOTE: Orient the adapter packs with the TE logo and numbering facing toward the front of the frame.

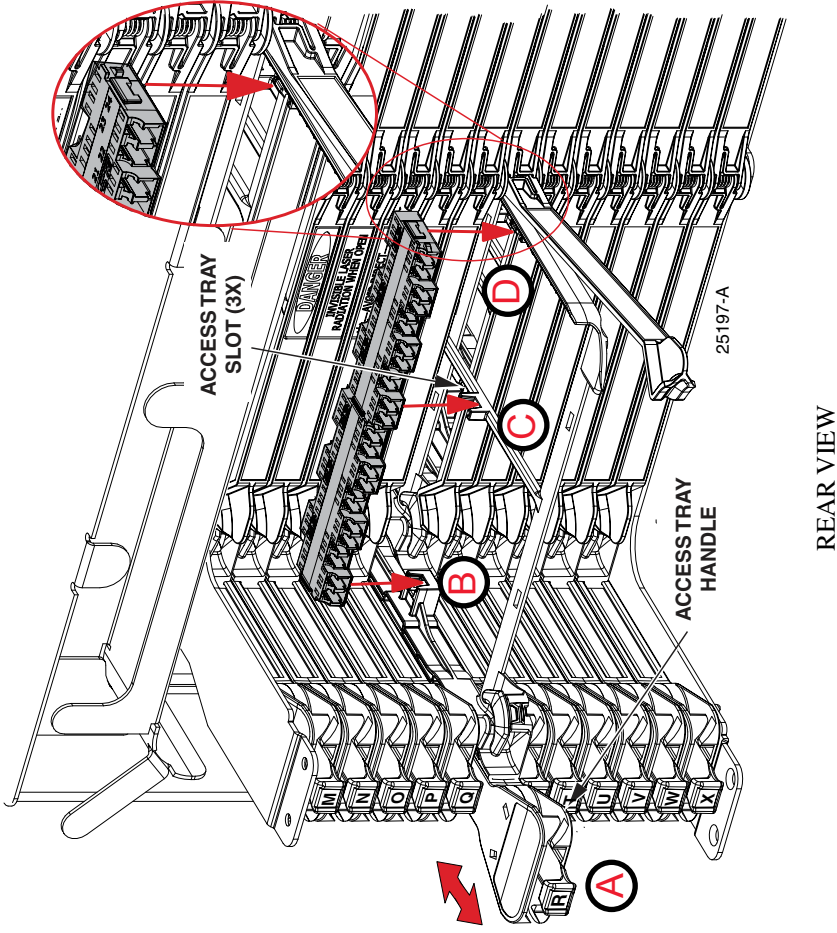

Flip these pages clockwise to view them horizontally.

Installing an IFC Module, VAM, or MPO Module

Open rear cover if present (not shown). Pull out access tray handle (A). Snap module into tray noting the five snap-in points (B), (C), (D), (E), and (F) called out below. Route fibers as shown on Page 10. Push in access tray handle. Close rear cover if present.

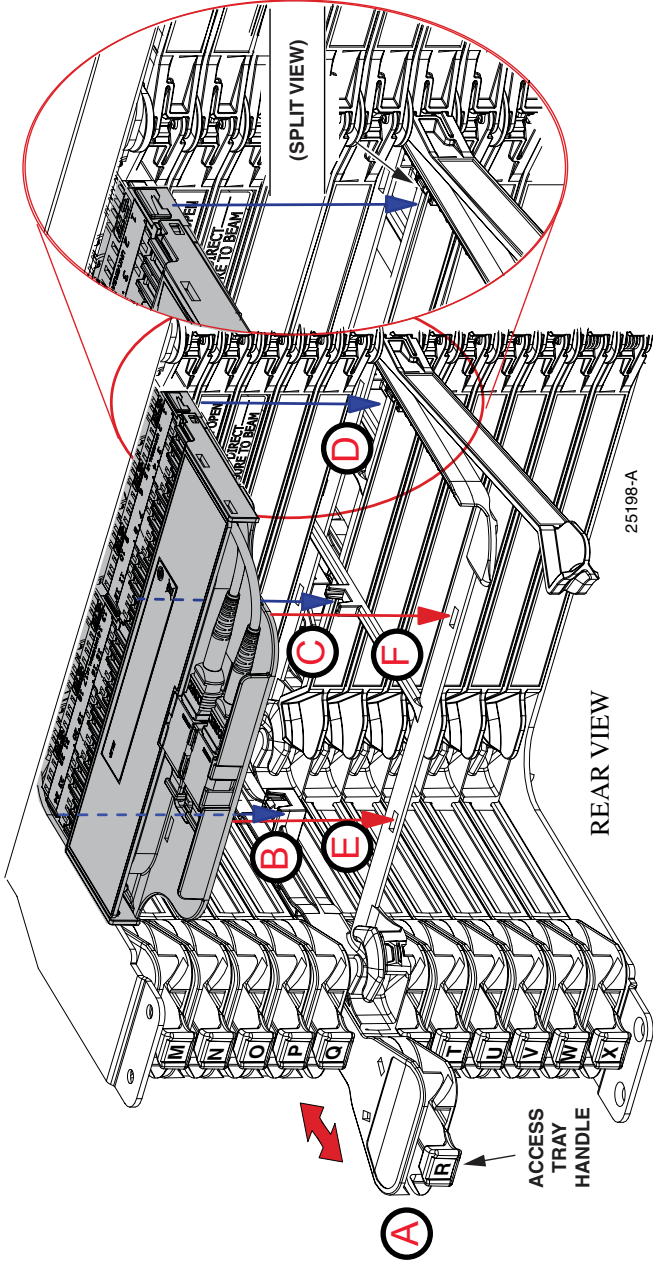

Routing Cables From Access Tray

Pull out access tray handle (A).
 Connect patch cord to adapter (B).
 Place patch cord within tray cable guide (C).
 Place patch cord around end of arm guide (D).
 Push in access tray handle to close tray. On right side of frame, route cable through cable trumpet flare (E) into vertical cable guides and down through trough.

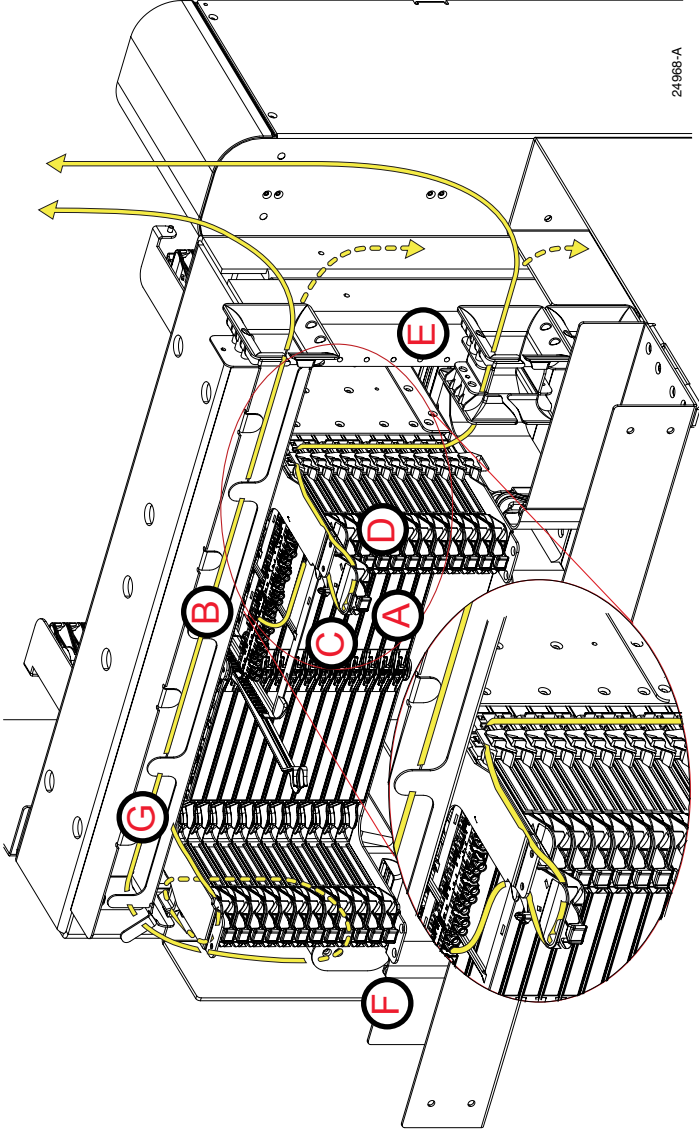

On left side of frame, route cable under radius limiter (F) and then up and into crossframe trough (G). When done, close cover if present (not shown).