

## Enhanced High Density (EHD) Panel With Preterminated Cable

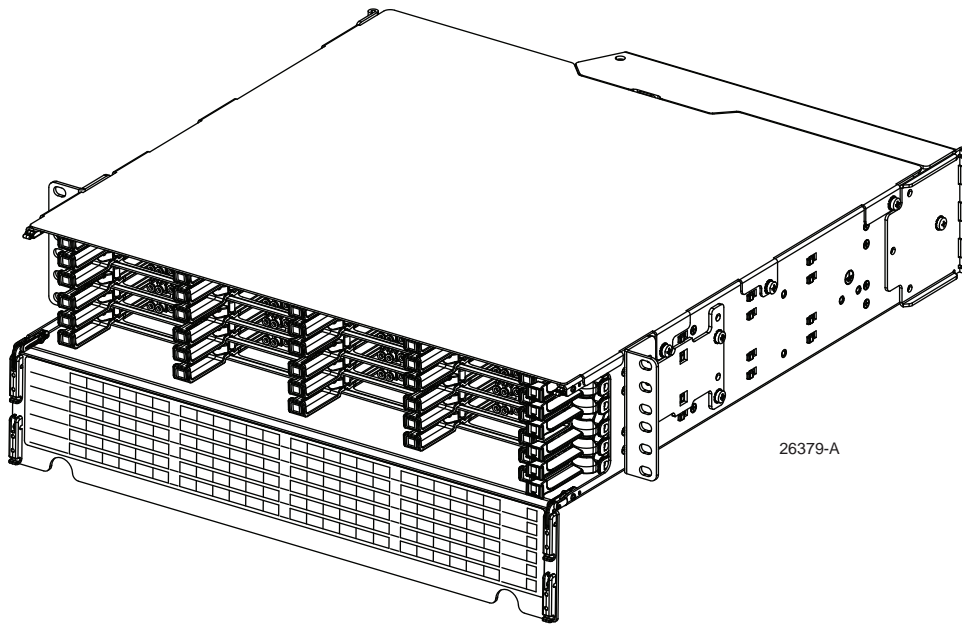

Content	Page
<b>INTRODUCTION</b> .....	<b>2</b>
Revision History .....	2
Trademark Information .....	2
Applicable Standards .....	2
Admonishments .....	3
General Safety Precautions .....	3
<b>1 PRODUCT DESCRIPTION</b> .....	<b>3</b>
1.1 General Description .....	3
1.2 Major Components .....	3
1.3 Transportation and Storage .....	5
1.4 Specifications .....	6
<b>2 UNPACKING AND INSPECTION</b> .....	<b>6</b>
<b>3 UNPACKING A PANEL WITH A PRETERMINATED CABLE</b> .....	<b>6</b>

(continued)

<b>4</b>	<b>PANEL INSTALLATION</b> .....	<b>13</b>
4.1	Overview .....	13
4.2	Tools and Hardware Needed .....	13
4.3	Mounting an Unloaded Panel .....	13
4.4	Grounding the Panel .....	16
<b>5</b>	<b>GENERAL CABLE REQUIREMENTS</b> .....	<b>17</b>
<b>6</b>	<b>OPERATION</b> .....	<b>18</b>
6.1	Sliding Out Blade to First Position .....	18
6.2	Accessing Connectors on Back of Adapter Pack .....	19
6.3	Closing Blade .....	19
6.4	Removing Blade from Front .....	20
6.5	Removing Fiber Cover .....	21
6.6	Re-Installing Fiber Cover .....	21
<b>7</b>	<b>TECHNICAL ASSISTANCE</b> .....	<b>22</b>

## INTRODUCTION

This user manual describes the Enhanced High Density (EHD) Panel, Included in this user manual are all procedures required in installing the EHD Panel as well as operation procedures.

## Revision History

ISSUE	DATE	REASON FOR CHANGE
1	9/2015	Original.
2	10/2015	Added minimum cable bend radius and maximum patch cord size.
3	3/2016	Added applicable standards and panel grounding instructions.
4	July 2016	Updated for front-access only design
E	October 2017	Updated for product name change to SYSTIMAX.
F	January 2019	Removed SYSTIMAX name; added transportation and storage guidelines.

## Trademark Information

CommScope (logo), CommScope, and Enhanced High Density Panel are trademarks.

## Applicable Standards

UL 60950-1, 2nd Edition, 2007-03-27 (Information Technology Equipment - Safety - Part 1: General Requirements)

CSA C22.2 No. 60950-1-07, 2nd Edition, 2007-03 (Information Technology Equipment - Safety - Part 1: General Requirements)

## Admonishments

Important safety admonishments are used throughout this manual to warn of possible hazards to persons or equipment. The admonishments — in the form of Dangers, Warnings, and Cautions — must be followed at all times.



**Danger:** *Danger is used to indicate the presence of a hazard that will cause severe personal injury, death, or substantial property damage if the hazard is not avoided.*



**Warning:** *Warning is used to indicate the presence of a hazard that can cause severe personal injury, death, or substantial property damage if the hazard is not avoided.*



**Caution:** *Caution is used to indicate the presence of a hazard that will or can cause minor personal injury or property damage if the hazard is not avoided.*

## General Safety Precautions



**Caution:** *When mounting equipment in the rack make sure mechanical loading is even to avoid a hazardous condition, such as loading heavy equipment in the rack unevenly. The rack should safely support the combined weight of all equipment it supports.*



**Caution:** *This equipment is to be installed only in Restricted Access Areas (dedicated equipment rooms, equipment closets, etc.) in accordance with Articles 110-16, 110-17, and 110-18 of the National Electrical Code, ANSI/NFPA 70.*

## 1 PRODUCT DESCRIPTION

### 1.1 General Description

The Enhanced High Density (EHD) Panel is a pre-terminated fiber optic connector panel intended for use in large data centers in a direct connect or interconnect environment. The EHD Panel mounts in a 19-inch (48.26 cm) equipment rack with a 3-inch or 5-inch channel. In each 1RU of rack space, a fully loaded panel provides 144 LC terminations using duplex LC adapters.

The EHD Panel is designed for ease of installation and access. It is available with either left- or right-side cable entry. The panel features sliding blades (three per 1RU of rack space), providing full access to adapters and connectors. Each blade can accommodate four adapter packs. The EHD Panel is available with either a black or sky white baked enamel exterior.

### 1.2 Major Components

Figure 1 shows the main components of the EHD Panel. They are as follows:

- ▶ **Note:** In this figure, the 2RU panel is shown. Main components are analogous for other RU sizes.

- **Blade**—holds adapter packs or cabled modules; slides out to two front access positions and is removable from front. There are three blades per RU rack space.

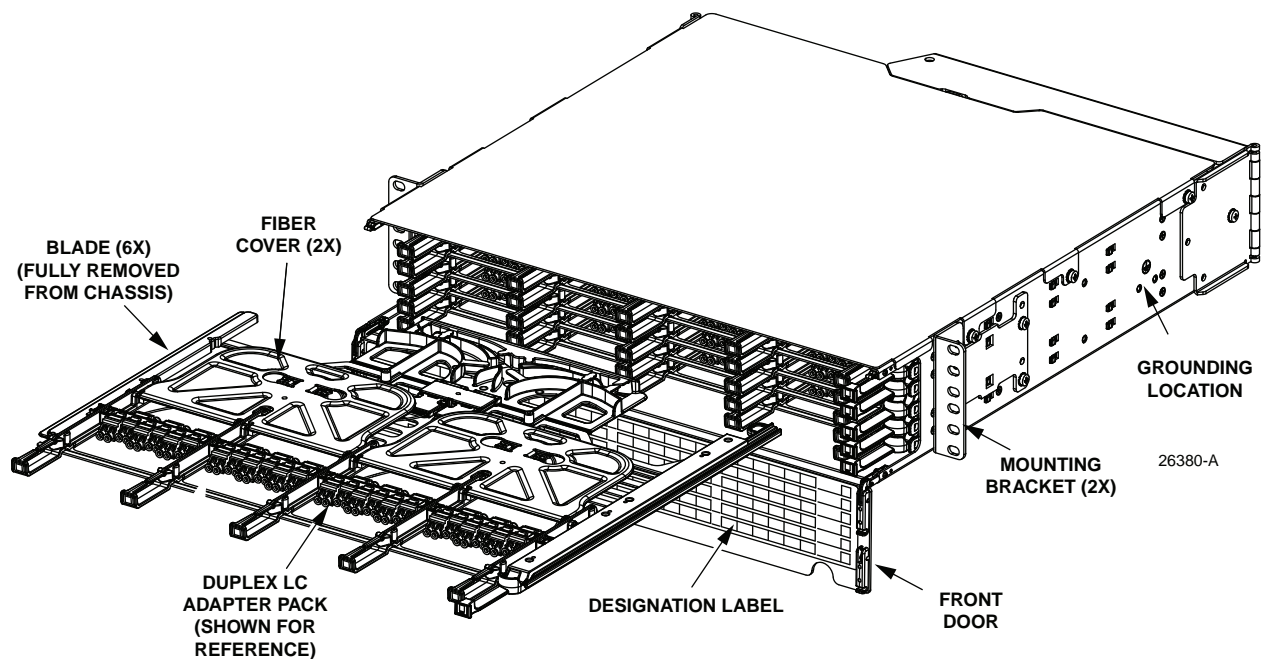

Figure 1. EHD Panel Main Components (2RU Model Shown)

- **Fiber Cover**—holds down fibers on each blade to prevent them from being inadvertently snagged or misrouted.
- **Grounding Location**—is where a two-hole lug and ground wire are attached to connect panel ground PEM nuts to office ground. A two-hole lug is provided with the product; the ground wire is not.
- **Mounting Brackets**—can be flipped around to provide either front- or rear-facing mounting on a channel rack.
- **Front Door**—swings down to provide access to the interior of the panel. The door features a double hinged design that allows users to open the door without interfering with equipment below the panel on the same rack, or also to allow the door to lay flat for easy access to the bottom blade.
- **Designation Label**—provides physical space for recording fiber designations.
- **Duplex LC Adapter Pack**—(shown for reference) mounts within the blade. Product offerings for adapter packs include LC adapter packs in singlemode APC or UPC style.

### 1.3 Transportation and Storage

Products packaged in cartons may be stacked two high in transportation and storage. Some products packaged in spools may be stacked two high in transportation and storage as shown in [Figure 2](#). See product packaging labels for designation.



**Figure 2. Stacked Spools**

## 1.4 Specifications

Table 1 lists specifications for the EHD Panel. Table 2 summarizes the supported adapter packs and modules for the EHD Panel.

**Table 1. EHD Panel Specifications**

PARAMETER	SPECIFICATION	REMARKS
Operating conditions	−14°F to +140°F (−10°C to +60C)	
Humidity	10% to 95% RH	No condensation
Storage conditions	−40°F to +158°F (−40°C to +70°C)	
Dimensions (2RU) D x W x H (with mounting brackets)	19.64 in. (49.9 cm) D x 19.09 in. (48.5 cm) W x 3.5 in. (6.04 cm) H	Width without mounting brackets: 17.27 in. (43.9 cm)
Weight per 2RU	23.4 lbs. (1.06 Kg)	

**Table 2. EHD Panel Supported Adapter Packs and Modules**

DESCRIPTION	FRONT CONNECTOR TYPE	FRONT PORT COUNT	REAR CONNECTOR TYPE	REAR PORT COUNT	FIBER CONFIGURATION
LC Adapter Pack	LC	24	LC	24	NA

## 2 UNPACKING AND INSPECTION

1. Inspect the exterior of the shipping container(s) for evidence of rough handling that may have damaged the components in the container.
2. Unpack each container while carefully checking the contents for damage and verify with the packing slip.
3. If damage is found or parts are missing, file a claim with the commercial carrier and notify CommScope Customer Service. Save the damaged cartons for inspection by the carrier.
4. Refer to [Topic 7 on Page 22](#) if you need to contact CommScope.
5. Save shipping containers for use if equipment requires shipment at a future date.

## 3 UNPACKING A PANEL WITH A PRETERMINATED CABLE

The pre-terminated panel is shipped with the panel mounted on top of a spool containing the cable. The stub end of the cable is unwound to a splice vault or other point of termination. To protect the panel and cable windings contained within the upper cylinder of the shipping unit, it is critical to leave the foam packaging material surrounding the panel in place until the unit has been transported to the final installation location. Transporting the unit without the foam packaging in place may result in damage to the panel and/or cable. To unpack and mount a fully loaded panel, use the following procedure.

- ▶ **Note:** Use caution when unpacking and installing the EHD Panel. Avoid twisting cable and do not violate cable minimum bend radius.
  - ▶ **Note:** Use caution when removing packaging materials. Sharp utensils can damage fiber optic cable.
1. Cut off the external plastic as shown in [Figure 3](#).



**Figure 3. Cutting Off External Plastic**

2. Cut off the cardboard wrap on the cable spool as shown in [Figure 4](#).



**Figure 4. Cutting Off Cardboard Wrap on Cable Spool**

3. Remove the four carousel locking screws shown in [Figure 5](#) to unlock the carousel, allowing the spool to rotate freely,

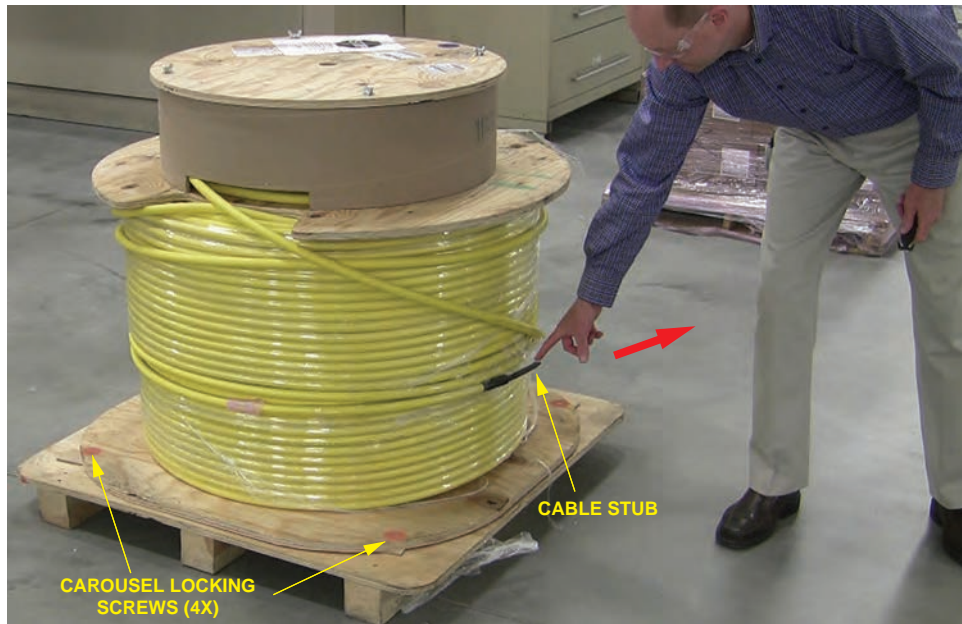

25873-A

**Figure 5. Carousel Locking Screws and Cable Stub**

4. Pay out the cable stub as indicated by the red arrow in [Figure 5](#), pulling cable end to termination location.
5. Remove the four wing nuts shown in [Figure 6](#).

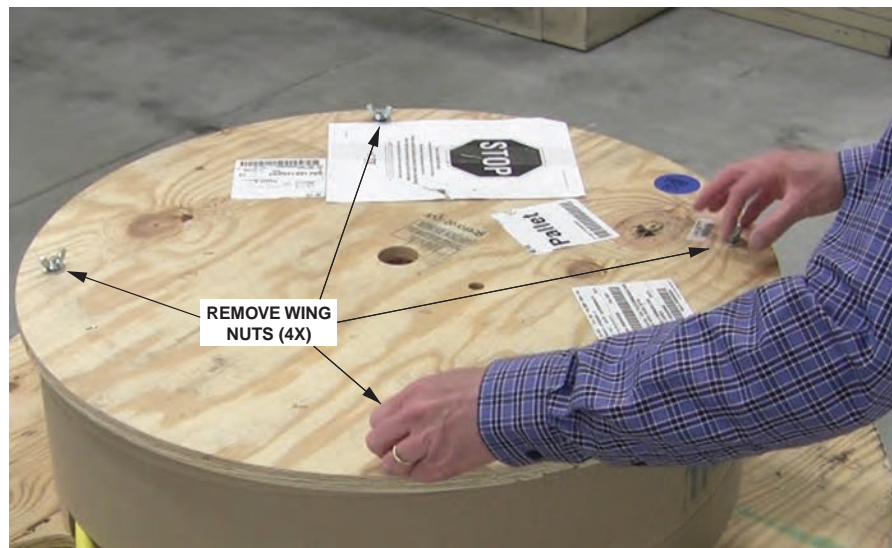

25874-A

**Figure 6. Removing Wing Nuts**



- Lift off the top cover to expose the panel packaging as shown in [Figure 7](#).



**Figure 7. Lifting Off Top Cover**

7. Remove the outer rim as shown in [Figure 8](#).



**Figure 8. Lifting Off Outer Rim**

8. Remove and unpack the accessories contained in shipment carton shown on top of the packaging foam in [Figure 9](#).



**Figure 9. Shipment Carton Containing Accessories**

9. Remove and unpack the plastic wrapper containing the EHD Panel, as shown in [Figure 10](#).



**Figure 10. EHD Panel in Plastic Wrapper**

10. Lift panel off of spool and carefully uncoil remaining cable. Use caution to avoid twisting the cable. Refer to [Figure 11](#).



**Figure 11. Lifting Off EHD Panel**

11. Follow the procedure given in [Topic 4](#) to install the panel on the frame.
12. Splice cable stub end per local practice, using blocking kit if required.

## 4 PANEL INSTALLATION



**Caution:** *This equipment is to be installed only in Restricted Access Areas (dedicated equipment rooms, equipment closets, etc.) in accordance with Articles 110-16, 110-17, and 110-18 of the National Electrical Code, ANSI/NFPA 70.*

### 4.1 Overview

The EHD Panel is shipped on a spool, preterminated with 144 LC connectors per rack unit (RU). It is available in both left- and right-cable-entry versions. A blocking kit is provided for the purpose of splicing the provided cable into a splice bay such as the OMX.

After mounting, the panel must be grounded. Use a #2 Phillips Screwdriver to tighten the M4 screws through the ground lug (provided) into the panel ground PEM nuts, as described in [Topic 4.4 on Page 16](#). Ground cables are NOT provided with the panel.

### 4.2 Tools and Hardware Needed

Use a #2 Phillips Screwdriver and the supplied #12-24 screws to secure the panel to the equipment rack.

### 4.3 Mounting an Unloaded Panel

The panel is to be installed in a 19-inch (482.6mm) equipment rack with a 3-inch or 5-inch channel. Use the following procedure to mount the 1RU/2RU panel.

1. Obtain the following tools and equipment:

- Phillips #2 screwdriver;
- Mounting hardware provided.

► **Note:** The panel is shipped with the mounting brackets already installed in the front position. If a rear position is desired, remove the brackets and install them in the rear position.

2. Determine whether the panel will be installed on front or rear and whether on a 3-inch or 5-inch channel. Install the mounting brackets provided in the locations shown in the following figures (which are representative of other RU sizes, also):

- [Figure 12](#) for 2RU mounting on a 5-inch channel;
- [Figure 13](#) for 2RU mounting on a 3-inch channel;
- [Figure 14](#) for 1RU mounting on a 5-inch channel; or
- [Figure 15](#) for 1RU mounting on 3-inch channel.

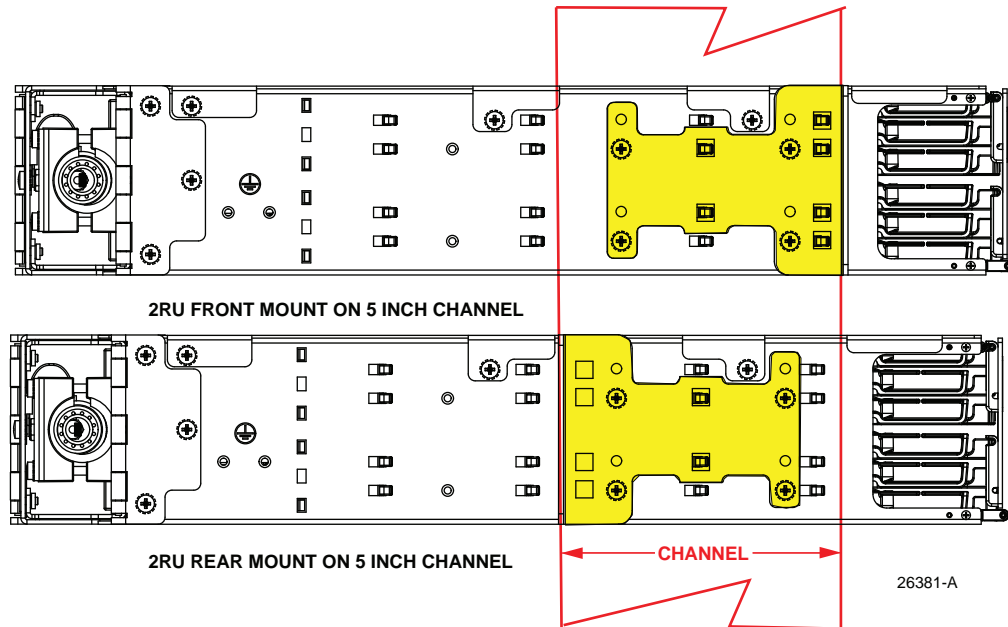

Figure 12. 2RU Mounting Bracket Positions (Front and Rear on 5-Inch Channel)

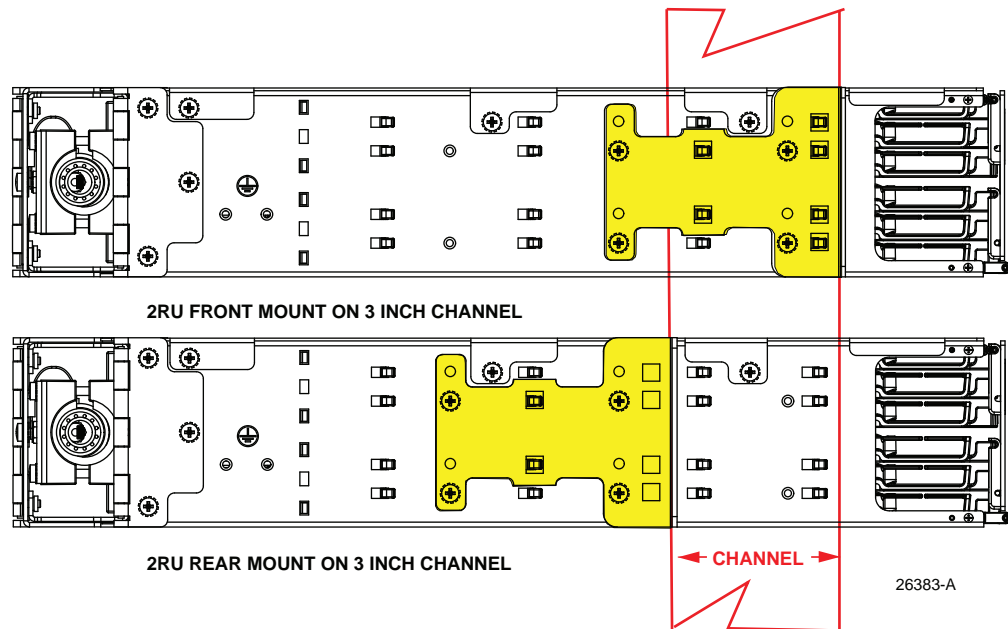
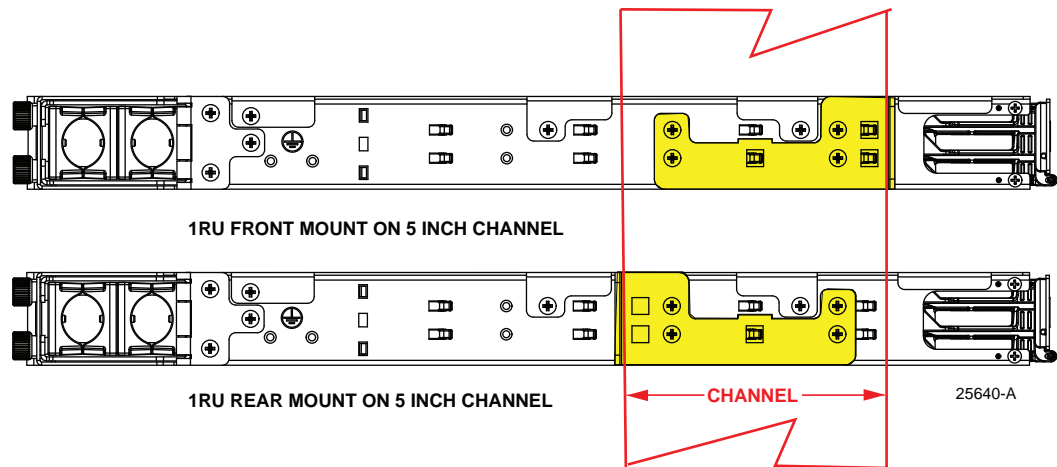
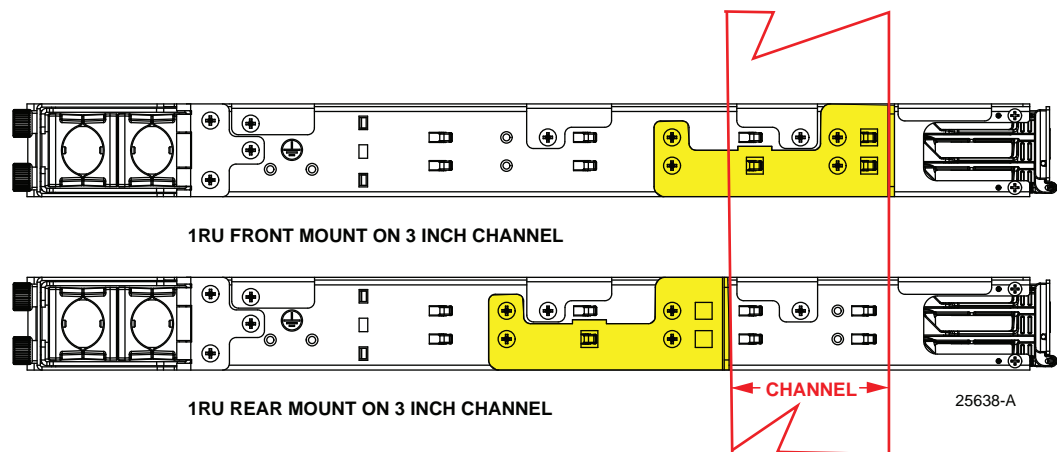

Figure 13. 2RU Mounting Bracket Positions (Front and Rear on 3-Inch Channel)



**Figure 14. 1RU Mounting Bracket Positions (Front and Rear on 5-Inch Channel)**



**Figure 15. 1RU Mounting Bracket Positions (Front and Rear on 3-Inch Channel)**

3. Hold the panel up to the assigned mounting space and align the holes in the mounting brackets with the holes in the equipment rack as shown in [Figure 16](#). Secure the panel to equipment rack using the #12-24 screws provided. Torque these screws to approximately 27 pound-inches (3.1 Newton meters).

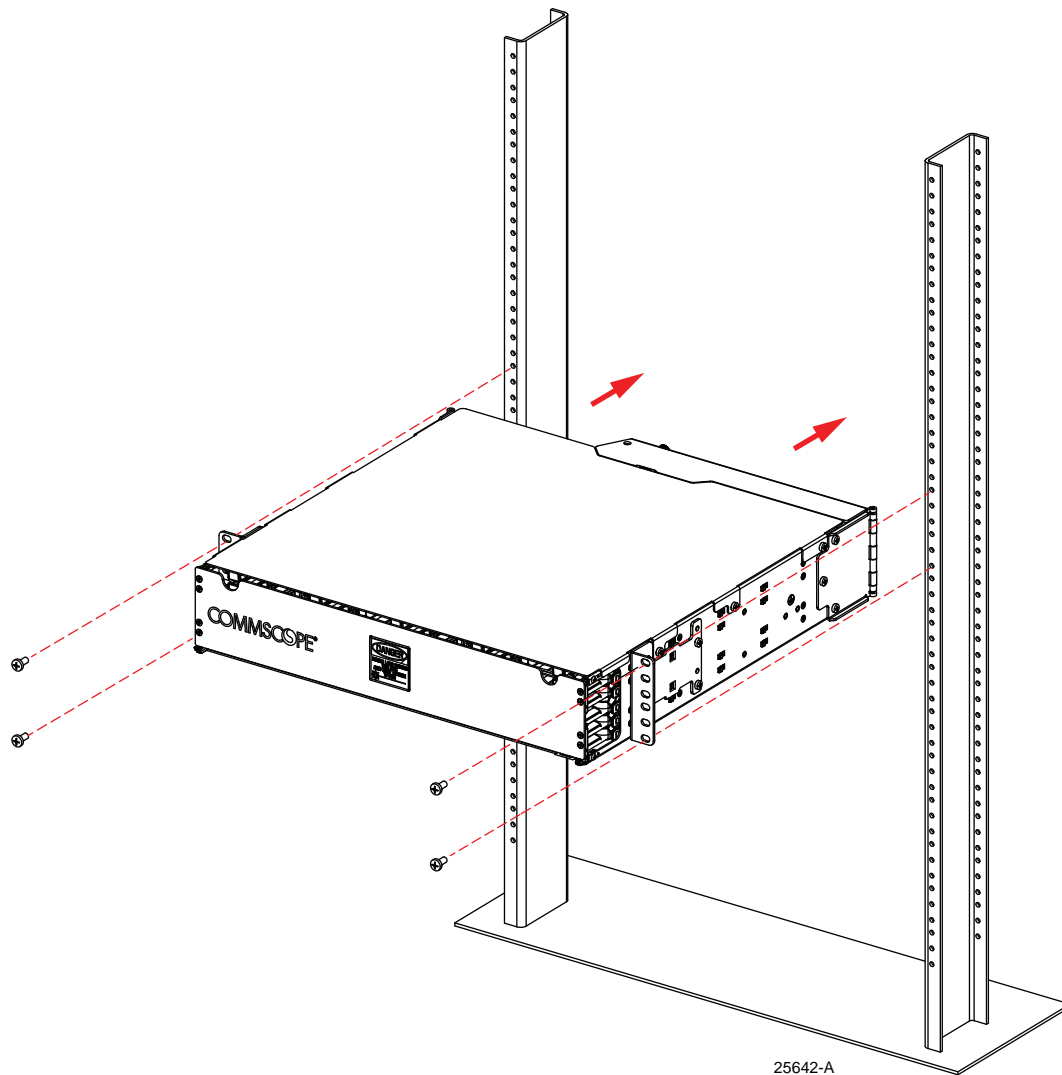

Figure 16. Mounting the Panel on the Equipment Rack (2RU Model Shown)

#### 4.4 Grounding the Panel

A termination (for an M4 screw) is provided on the panel for a frame ground connection. The connection must be made in accordance with local and national electrical codes. Use the following procedure, referring to [Figure 17](#).

1. Locate the ground location on the panel. At the grounding location, remove the protective tape from the panel.



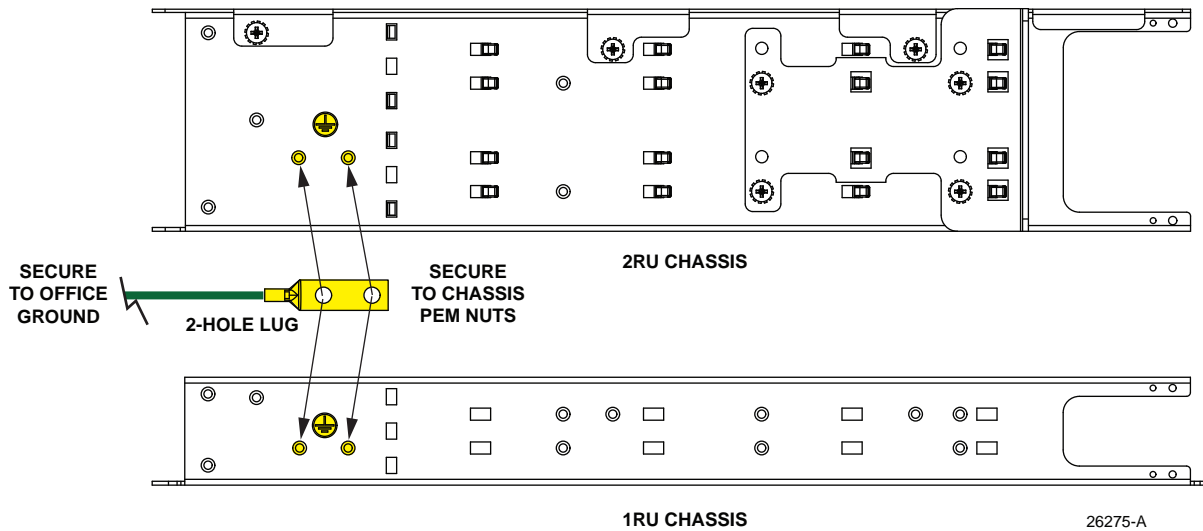

Figure 17. Grounding the Panel

- Using AWG 14 (1.6mm) solid copper wire, secure a crimp lug to one end of the ground wire (installer provided). Secure the crimp lug to panel with two M4 screws. Torque the screws to approximately 15 pound-inches (1.7 Newton meters).



**Caution:** *Reliable earthing of rack-mounted equipment should be maintained. Particular attention should be given to supply connections other than direct connections to the branch circuit.*

- Connect the other end of the ground wire to the earth ground conductor. Ensure this connection is made using methods and hardware that meets all applicable local and national electrical codes.

## 5 GENERAL CABLE REQUIREMENTS

Pre-terminated EHD Panels use RBR G657.A1 reduced-bend-radius singlemode fiber. Installers need to follow the manufacturer recommended settings when testing and splicing the RBR G657.A1 fiber to the G.652 standard singlemode fiber. Please alert contractors to this fact.

The minimum cable bend radius is 10 inches (25.4 cm).

CommScope recommends the following type patch cords for use in the EHD Panel:

- 2-Fiber UPC LC Singlemode Dual-Zip 1.7mm patch cord FPCT-SPLC-S-xM

- 2-Fiber UPC LC Singlemode Dual-Zip 1.7mm RBR patch cord FPCTE-SPLC-S-xM
- 2-Fiber UPC LC Singlemode Dual-Zip 2mm patch cord FPC2-SPLC-S-xM
- 2-Fiber UPC LC Singlemode Dual-Zip LSZH 2mm patch cord FPCH2-SPLC-S-xM
- 2-Fiber UPC Duplex LC Singlemode Dual-Zip 1.7mm patch cord FPCT-SDLC-S-xM
- 2-Fiber UPC Duplex LC Singlemode Dual-Zip 1.7mm RBR patch cord FPCTE-SDLC-S-xM
- 2-Fiber UPC Duplex LC Singlemode Dual-Zip 2mm patch cord FPC2-SDLC-S-xM
- 1-Fiber UPC LC Singlemode 1.7mm patch cord FPCF-SPLC-S-xM
- 1-Fiber UPC LC Singlemode 2mm patch cord FPCM-SPLC-S-xM

The maximum patch cord size that can fit in the panel is 2mm simplex or duplex.

## 6 OPERATION

### 6.1 Sliding Out Blade to First Position

To slide out a blade to the first (access) position, pull out the pull arm on the right side of the panel until the blade contacts the first detent, as shown in [Figure 18](#).

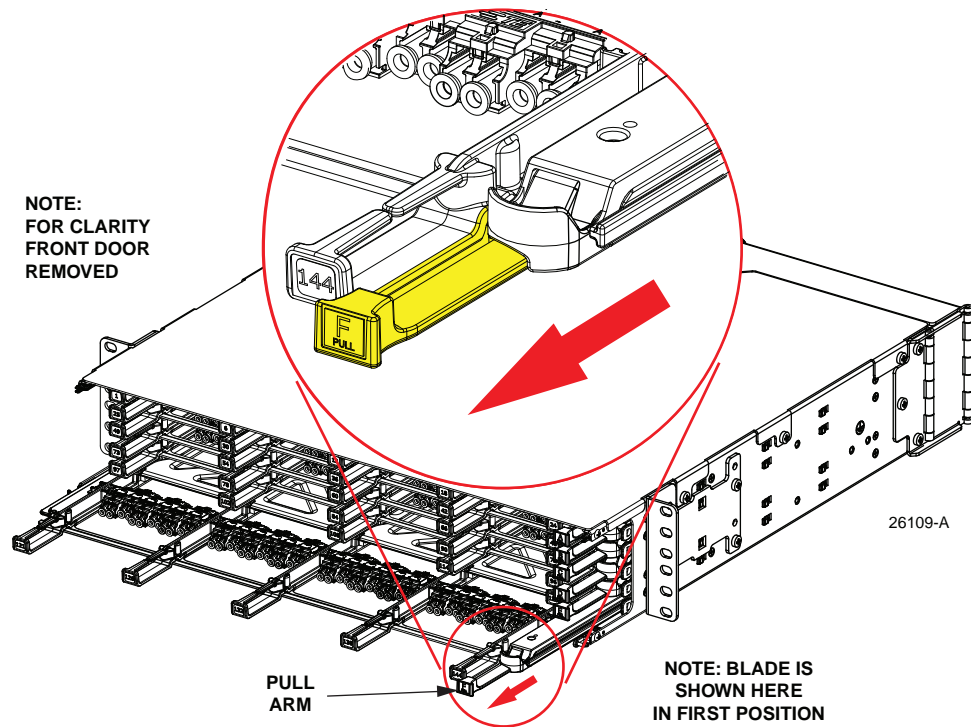

Figure 18. Sliding Out Blade to First (Access) Position

## 6.2 Accessing Connectors on Back of Adapter Pack

To access the connectors on the back of an adapter pack, use the following procedure (refer to [Figure 19](#)):

1. Place index finger into the concave loop on the slide mechanism, place thumb on the pull arm, and squeeze index finger and thumb together.
2. Slide out the blade until it stops in the second position, which permits the connectors on the back of an adapter pack to be accessed.

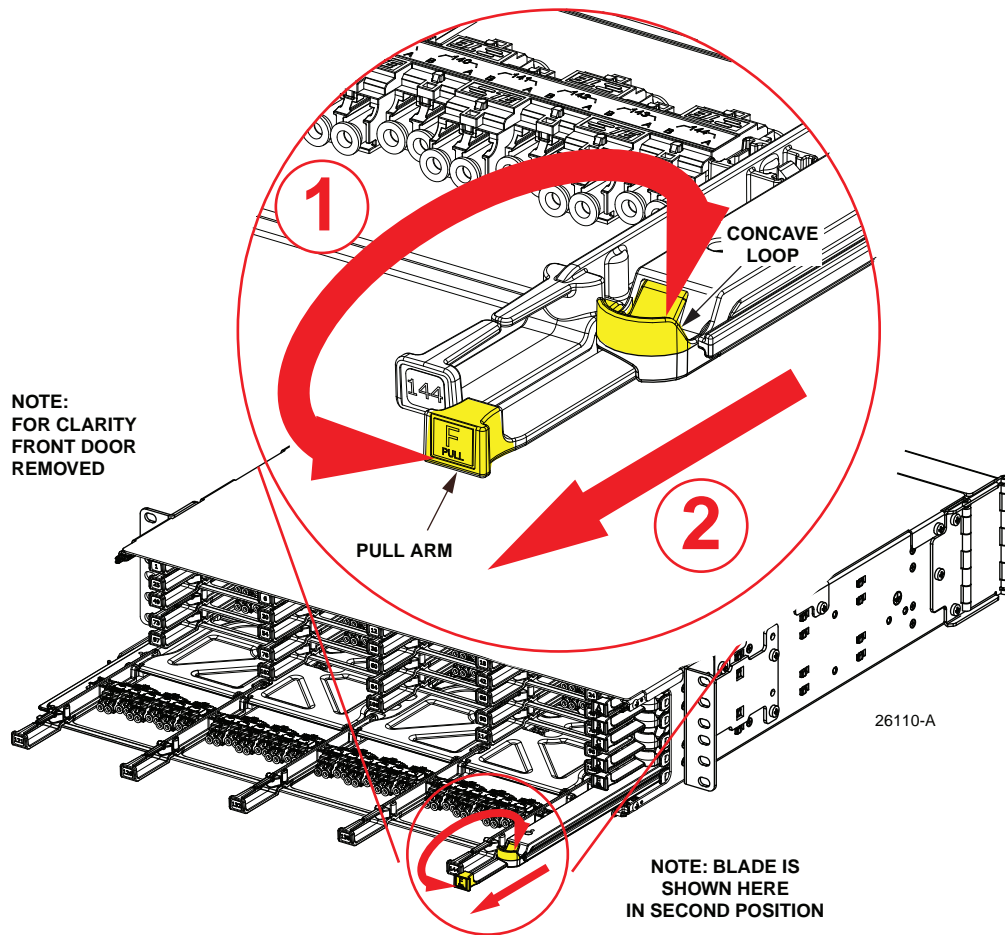

Figure 19. Sliding Out Blades to Second Position

## 6.3 Closing Blade

To close a blade, push in the push handle on the right side of the panel until the blade is fully within the panel.

► **Note:** This is the opposite action to what is shown in [Figure 18 on Page 18](#).

## 6.4 Removing Blade from Front

To remove a blade from the front of the panel (Figure 20):

1. Deflect the tab outward on the right side of the panel.
2. Pull on a gray fiber management finger (not the white pull handle). The gray management finger is highlighted in yellow in the figure.



**Caution:** Pulling too far will damage the ribbons entering the back of the blade on a pre-terminated panel.

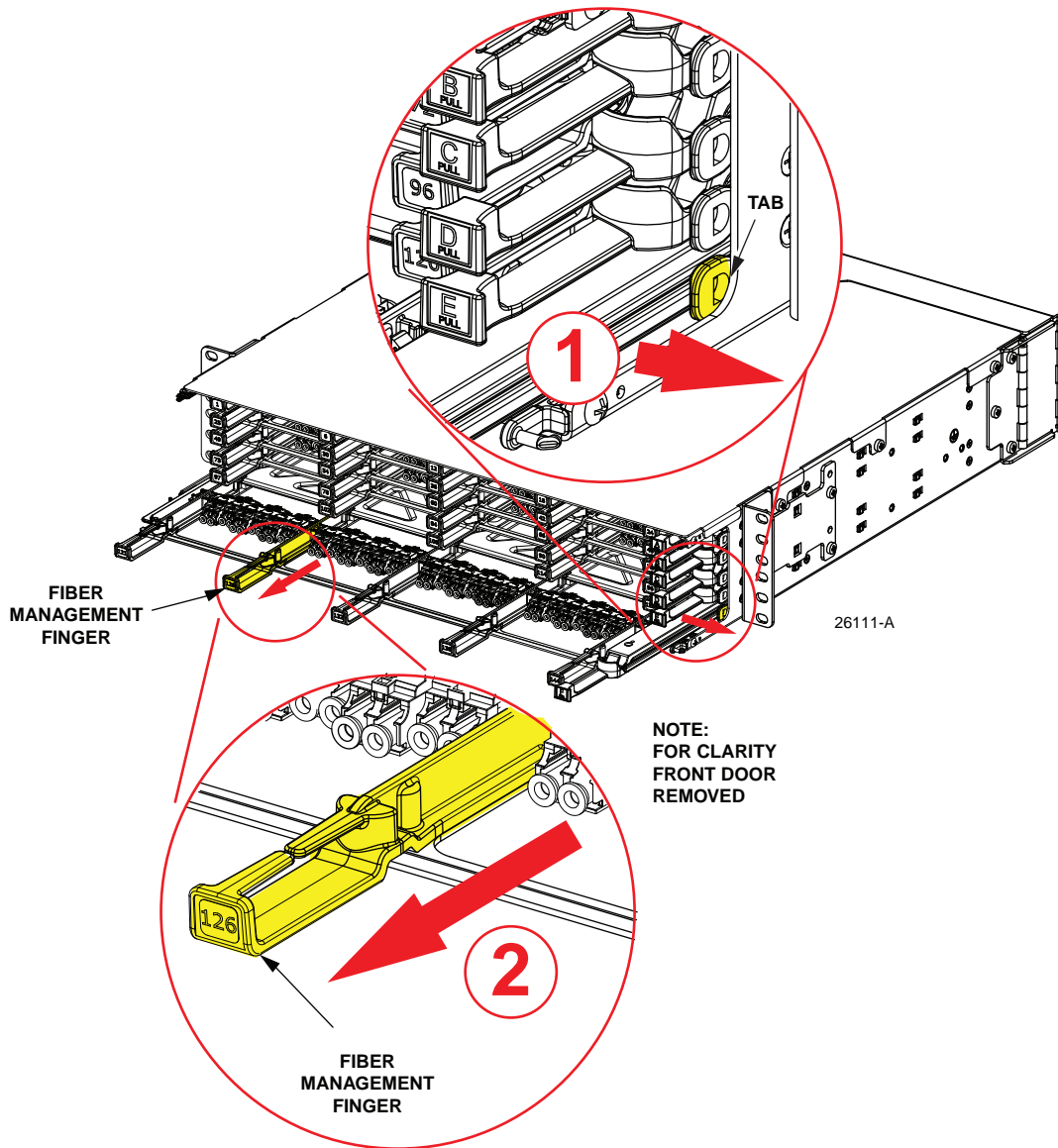

Figure 20. Removing Blade From Front

## 6.5 Removing Fiber Cover

To remove the fiber covers, remove the blades as described in [Topic 6.4 on Page 20](#) until the center is fully exposed, then:

1. Squeeze the fingers at the center of the covers per the arrows shown in [Figure 21](#).
2. Pull upward on the cover and lift it off the blade.

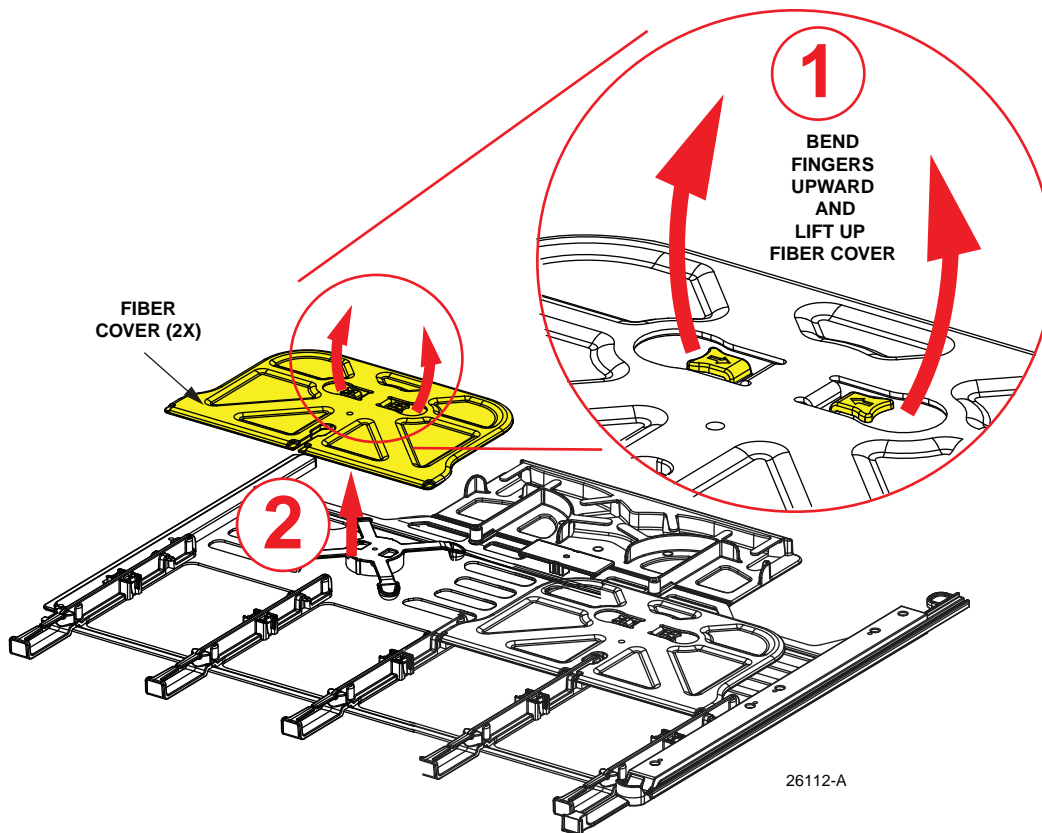

Figure 21. Removing Fiber Covers

## 6.6 Re-Installing Fiber Cover

To reinstall the fiber cover:

1. Align the fiber cover with its home location and tilt the cover at about a 45 degree angle and position the tip of the cover within the guides indicated in [Figure 22 detail 1](#).

2. Swing down the cover until it presses into and locks within the cover holder indicated in Figure 22 detail 2.

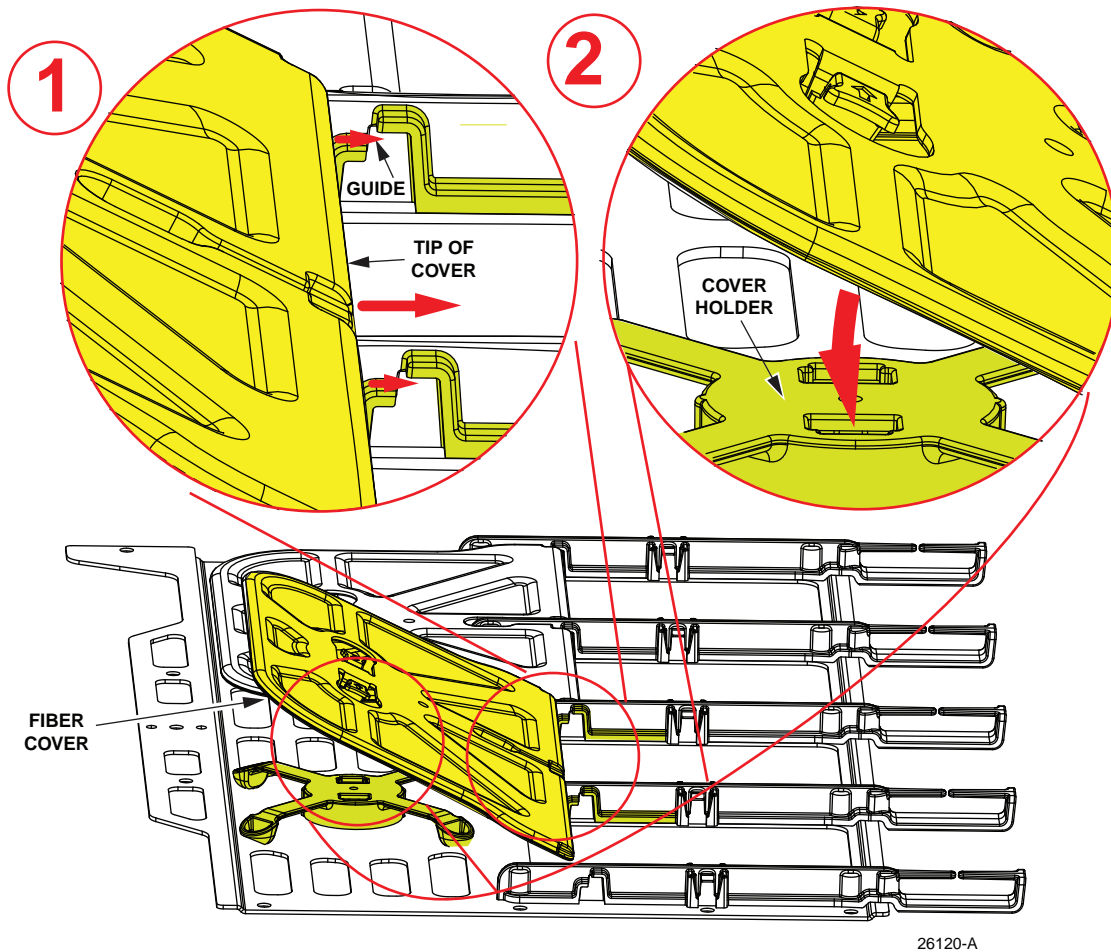

26120-A

Figure 22. Re-Installing Fiber Cover

## 7 TECHNICAL ASSISTANCE

To find out more about CommScope® products, visit us on the web at [www.commscope.com](http://www.commscope.com)

For technical assistance, customer service, or to report any missing/damaged parts, visit us at <http://www.commscope.com/SupportCenter>

