

# SYSTIMAX<sup>®</sup>

## SOLUTIONS



### SYSTIMAX<sup>®</sup> M4CA Variable Furniture Faceplate

#### Product Description

The M4CA kit may be ordered in black, ivory, white, or gray. Please use the Material ID No. below when ordering. Each kit measures 2.975" H by 4.725" W by 0.5" D (75.6 mm H by 120 mm W by 12.7 mm D).

Kit No.	Material ID	Color	Kit No.	Material ID	Color
M4CA-003	700 189 046	Black	M4CA-262	700 191 588	White
M4CA-246	700 191 570	Ivory	M4CA-270	700 191 596	Gray

The M4CA mounts on flat surfaces with a rectangular hole size ranging from 1.7" H by 2.892" W (43.18 mm H x 73.46 mm W) to 2.375" H by 4.125" W (60.33 mm H by 104.78 mm W), with a thickness of 0.025" to 0.125" (0.63 mm to 3.18 mm).

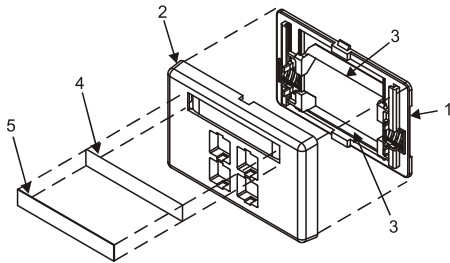

#### Parts List:

1. Frame
2. Cover
3. Latch Bars (Shipped assembled to frame)
4. Label
5. Label Cover

#### How to Contact Us

- To find out more about **SYSTIMAX<sup>®</sup>** Solutions, visit us on the web at <http://www.systimax.com/>
- For technical assistance regarding **SYSTIMAX** products:
  - Within the United States, contact your local account representative or **SYSTIMAX** technical support at 1-800-344-0223. Outside the United States, contact your local account representative or Authorized BusinessPartner.
  - Within the United States, report any missing or damaged parts to **SYSTIMAX** Customer Service in Omaha, NE, at 1-866-539-2795. Outside the United States, contact your local account representative or Authorized BusinessPartner.

#### Installation Instructions

1. Pull wires through panel cutout, and terminate to "M" series information outlets.
2. Feed wires through the frame, in between the two latch bars as shown.

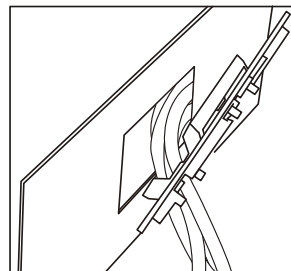
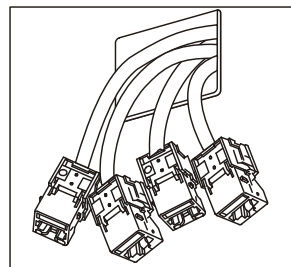

**860 019 074**  
**Instruction Sheet**

3. Install frame in cutout by hooking lower latch bar over the bottom edge of the panel cutout.

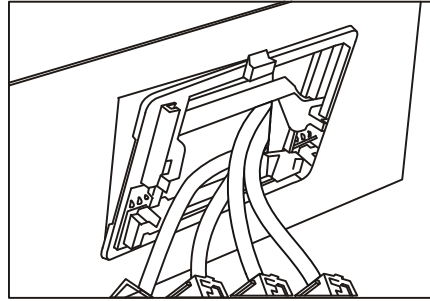

4. Push frame flat to the panel, while moving the upper latch bar tight against the top panel cutout edge.

**Note:** The leaf springs will deflect dependent on panel cutout width, providing lateral positioning to the frame as needed. There is no need to break off the leaf springs to adapt to smaller openings.

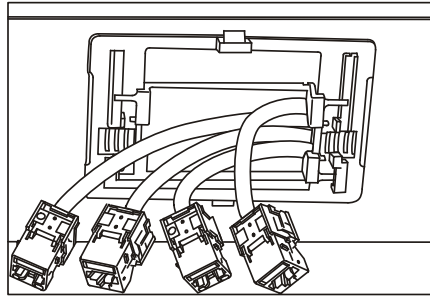

**Note:** If it is necessary to remove the frame from the panel, squeeze the upper latch finger tabs to release the ratchet and the latch can be slid away from the panel cutout edge. Finger tab locations shown.

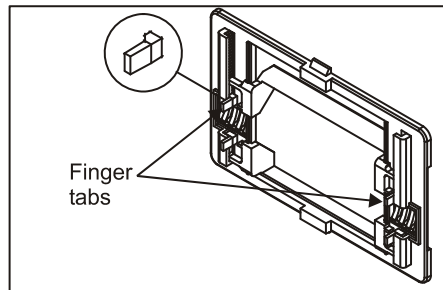

5. Snap the "M" series information outlets into the cover.

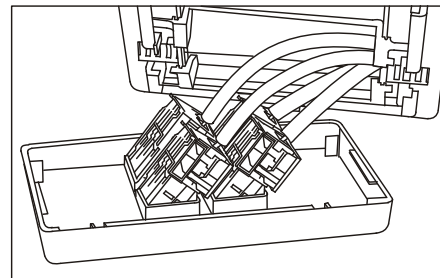

6. Snap the cover on the frame with the modules aligned with the hole in the frame.

**Note:** The cover can be removed by prying the cover from the base by inserting a straight blade screwdriver into the pry slot located on either side of the cover, and twist.

