

# A planning guide to optimizing networks for capacity with practical field examples

Mobility Network Engineering

Dr. Mohamed Nadder Hamdy

October 2017

# Contents

<b>Introduction</b>	<b>4</b>
1 Abstract	4
2 Dimensioning challenges	4
3 The three capacity domains	4
<b>First domain: densification</b>	<b>5</b>
4 Adding macro sites	5
5 High-order sectorization—HoS	5
5.1 Multibeam antennas	5
5.2 Combiners	7
6 Heterogeneous networks	9
6.1 Outdoor small cells	9
<b>Second domain: efficiency</b>	<b>10</b>
7 Spectral efficiency	10
7.1 High-performance antennas—BSA	10
7.2 Tower-mounted amplifiers—TMA	11
8 Cost efficiency	13
8.1 PowerShift	13
8.2 Site and antenna sharing	14
9 Deployment efficiency	15
9.1 Pre-assembled tower tops	15
<b>Third domain: spectrum</b>	<b>16</b>
10 Mobile bands and spectrum allocation regulations	16
10.1 The ITU	16
10.2 The WRC	16
10.3 Ultra-wideband antennas	16
11 IMF filters	17
11.1 The leakage problem	17
11.2 The IMF solution	17
12 Passive intermodulation—PIM	18
12.1 PIM basics	18
12.2 Measuring PIM	19
12.3 Practical tips for PIM improvement	21
<b>References</b>	<b>23</b>

# List of figures

Figure 1: Data units	4
Figure 2: Cisco VNI report—February 2017	4
Figure 3: Ericsson mobility report—November 2016	4
Figure 4: Twin-beam antenna patterns	5
Figure 5: Butler Matrix	6
Figure 6: Twin-beam simulations	6
Figure 7: A hybrid multibeam	7
Figure 8: Stadium multibeam	7
Figure 9: A CommScope multiband combiner with dc smart bypass—block diagram	8
Figure 10: A CommScope twin penta-plexer and LLC900 MHz	8
Figure 11: Side-by-side twin array and CommScope filtered antenna	8
Figure 12: A CommScope quasi omni	9
Figure 13: CommScope concealment solutions	9
Figure 14: Evolution of spectral efficiency	10
Figure 15: H-HPBW comparison	11
Figure 16: Link imbalance	11
Figure 17: A CommScope TMA1800/2100 example	12
Figure 18: CommScope triband TMA1800/2100/2600	12
Figure 19: CommScope quad- and penta-band TMA	12
Figure 20: A PowerShift base unit	13
Figure 21: PowerShift diagram	13
Figure 22: Antenna sharing scenarios	14
Figure 23: HELIAX FiberFeed hybrid advantage	15
Figure 24: HELIAX FiberFeed hybrid solution building blocks	15
Figure 25: ITU regions	16
Figure 26: Ultra-wideband antenna examples	16
Figure 27: Adjacent interference	17
Figure 28: A CommScope IMF	17
Figure 29: IMF effect	17
Figure 30: Harmonic distortion	18
Figure 31: IMD and PIM order	18
Figure 32: IEC 62037 reverse and forward PIM measuring	19
Figure 33: IEC 62037 internal PIM effect	20
Figure 34: PIM calculator	21
Figure 35: Connector cross sections	22
Figure 36: D-class jumpers	22

# Introduction

## 1 | Abstract

Think about the challenges capacity planners have to face when it comes to forecasting and future planning their mobile networks efficiently. Over-dimensioning is unforgivably wasted cash—while under-dimensioning is a catastrophic revenue loss.

This paper aims to explain how to select and utilize your sites' RF components to optimize cellular networks' capacities. It includes real-life product examples whose continuously updated part numbers can be easily checked from CommScope's web portal.

## 2 | Dimensioning challenges

The Yankees' Yogi Berra once said, "It's tough to make predictions, especially about the future." As hilarious as it sounds, it still stands true!

Luckily we do get industrial reports, which tend to give us guidance about telecom trends and future expectations. I am personally a fan of the Cisco Visual Network Index<sup>i</sup> and Ericsson's Mobility<sup>ii</sup> reports.

In February 2017, Cisco forecasted mobile data traffic to increase sevenfold between 2016 and 2021. According to them, this traffic will grow at a compound annual growth rate (CAGR) of 47 percent from 2016 to 2021.

Putting this next to unit labels translates to 49.0 exabytes per month by 2021. That's more than half a zettabyte per year. For those who lose track of units beyond terabytes, like me, here is a summary in Figure 1. I guess we'll keep on searching for new unit names as we go on in time!

When it comes to the mobility share in traffic, both reports show gigantic growths—mainly driven by video consumption and 4G adoption.

## 3 | The three capacity domains

Now that we've identified our problem's magnitude, how can we prepare? And what arsenal of equipment would we need? Let's take a step back into theories—to the famous Shannon-Hartley equation, to be specific.

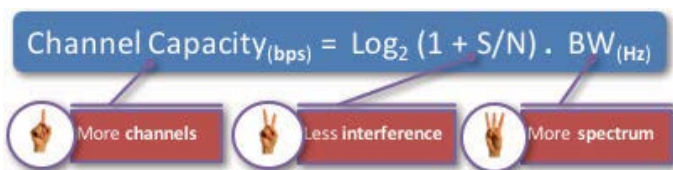

The equation shows three main directions for expanding on capacity:

1. More channels (densification): The number of cells per square kilometer
2. Less interference (efficiency): Higher SINR leads to better spectral efficiency bps/Hertz
3. More bandwidth (spectrum): This can also include offloading to nonlicensed bands.

In the following sections, we'll look into each of these domains, illustrating practical field-deployable products.



Figure 1: Data units

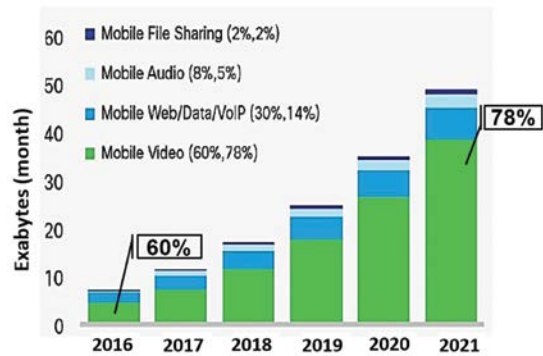

Figure 2: Cisco VNI report—February 2017

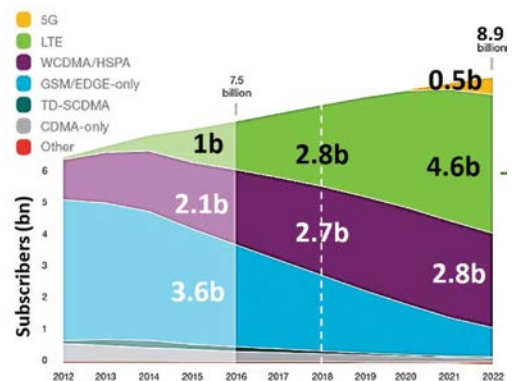

Figure 3: Ericsson mobility report—November 2016

# First domain: densification

## 4 | Adding macro sites

Densification is about adding more cells for expansions. It can be expressed in number of cells per square kilometer. Traditionally, adding new macro sites between existing ones has been the solution. Yet, by now, most networks already have very short macro site to site distances in their hotspot areas. Adding more macro sites without risking overlap and interference is becoming an impossible task. Here are other practical methods to densify:

- High-order sectorization (HoS)
  - Multibeam antennas
  - Combiners
- Heterogeneous networks
  - Small cells
  - In-building solutions

## 5 | High-order sectorization (HoS)

### 5.1 Multibeam antennas

There are two main challenges that can block adding more antennas for your HoS implementations:

- Excessive tower wind loading
- Sectors overlapping

CommScope designers have considered these problems when designing their solution. A narrow-width panel antenna radiating multiple beams with minimized overlap is compared to two 65° antennas, as illustrated in Figure 4.

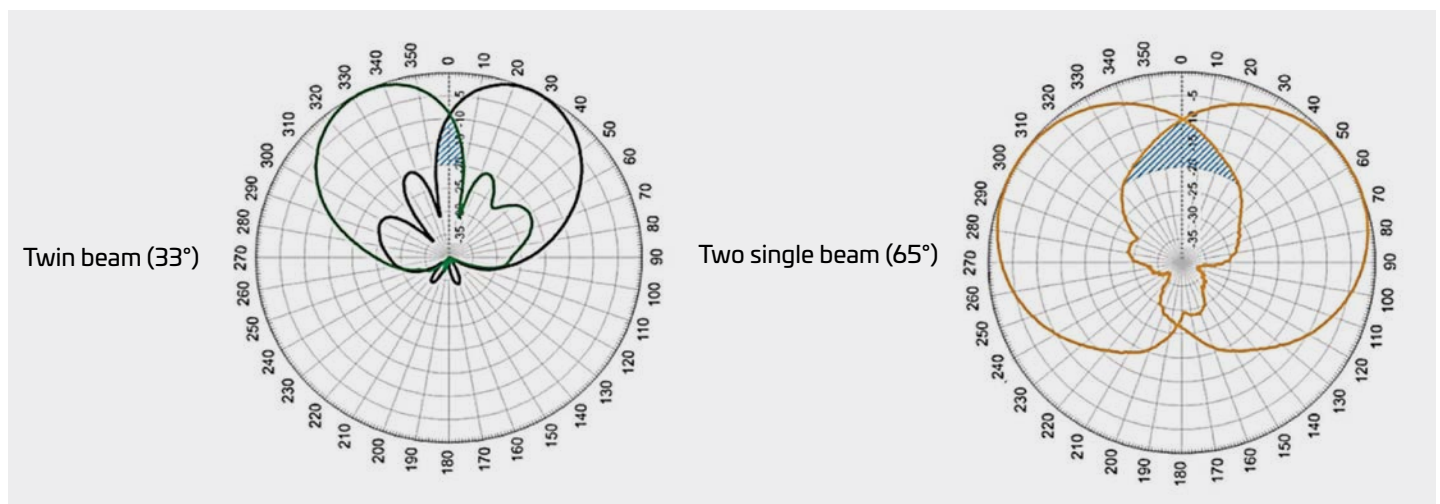

Figure 4: Twin-beam antenna patterns

# First domain: densification

## Construction

To achieve such narrow-width form factors, the antenna is built over a network of phase shifters and hybrid combiners—or so-called Butler Matrix. Here, both beams are radiated from a single shared aperture, that is no bigger than a single beam antenna of similar HPBW. This maintains similar towers' wind loading before and after upgrade from single beam antennas.

## Simulation

To judge on performance, RF simulations were conducted, as shown in Figure 6. After tilt optimization, impacts on coverage and throughput are very promising. The table also shows that overall throughput gain is in the range of 1.6 to 1.8 times.

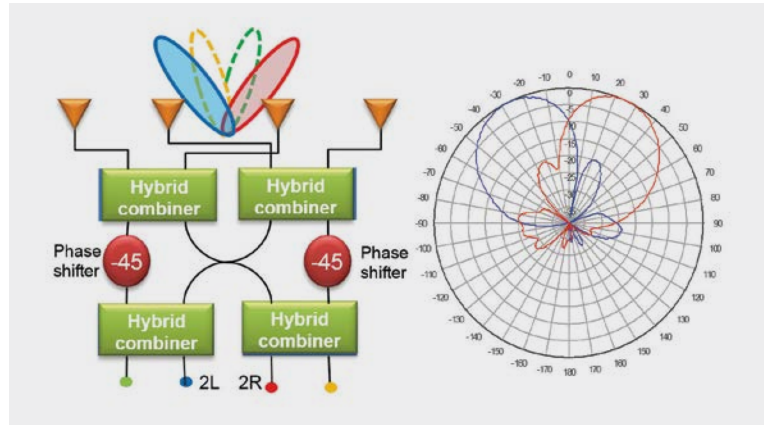

Figure 5: Butler Matrix



Figure 6: Twin-beam simulations

## Application—spectrum refarming

Among numerous use cases, twin-beam antennas have been used for freeing up UMTS spectrum for LTE use. Consider an operator with four UMTS carriers—F1, F2, F3 and F4—running on three-sector sites. This gives a total of three sectors x four carriers = 12 cells per site.

Now, upgrading this into twin-beam antennas with only two carriers (F1 and F2) results in a total of six sectors x two carriers = 12 cells per site. This frees up F3 and F4 for LTE re-farming while maintaining the same number of cells per site.

# First domain: densification

## Multibeam antenna configurations

Due to its importance, there exists a wide variety of multibeam antennas covering different beams, bands and gains. Some real products specs are listed here:

- **Twin beam in low band**  
Dual beam 4x 790–960 MHz, HPBW 37°
- **Twin beam in high band**  
Dual beam 4x 1695–2400 MHz, HPBW 33°
- **Hybrid multibeam (single+twin beams)**  
Single beam 2x 694–960 MHz, HPBW 65°  
+Single beam 4x 1695–2690 MHz, HPBW 65°  
+Dual beam 4x 1695–2180 MHz, HPBW 33°
- **Twin beam in multiband**  
4x698–894 and 4x1710–2180 MHz,  
HPBW 35°
- **Twin beam with 4x4 MIMO**  
8x1695–2200 MHz, HPBW 38°
- **Five beams in high band**  
H-HPBW 10–14°, V-HPBW 11°
- **Five beams in low band**  
H-HPBW 13.5°, V-HPBW 13.6°
- **2x9 beams in high band**  
H-HPBW 6.3°–5.1°, V-HPBW 7.2°–5.8°



Figure 7: A hybrid multibeam



Figure 8: Stadium multibeam

## 5.2 Combiners

A second technique for implementing HoS is realizable by using RF combiners—cells on different frequencies, bands or technologies combined to share the same RF path of coaxial cables and antennas. Combiners can:

- Add new technologies without adding feeders or antenna ports
- Reduce feeder runs for loaded towers or narrow monopoles

The combiners are further classified into Multiband (x-plexers), Same Band and filtered antennas.

### Multiband combiners (x-plexers)

Different bands are easier to combine as they have the luxury of large guard bands in between. This makes filter design significantly easier and cheaper with low insertion losses (0.1–0.3 dB typical). The multiband combiners' portfolio includes diplexers, triplexers, quad-plexers and even penta-plexers. They are designed for combining standard bands and are usually not customized over-the-shelf products.

One of the challenges usually faced when adding combiners between the BTS and antenna line devices (ALD) is blocking the dc power and AISG signaling path. Operators used to specify fixed bypass ports on the combiners. This was logistically challenging to reconfigure or move between sites. A recent evolution was adding the so-called “dc smart bypass” functionality. Its primary function is to provide “automatic” internal routing of DC/AISG between “input/output” ports without the requirement for external dc stops or specific “fixed” bypass model(s). This enables “fail-safe” field configuration/installation where DC/AISG is required to ALDs such as TMAs, smart bias tees, etc. On-board (optional) LEDs provide real-time visual indication to field engineers of the “condition” of each of the ports and the presence of dc voltage within the system.

# First domain: densification

## Same-band combiners

With the spread of software-defined radios (SDRs), it has become common to run traditional technologies on new bands—as long as the handsets support it. For example, many operators are adding new UMTS 900 MHz radios to share their existing GSM 900 MHz antennas. When there are no defined guard bands between the to-be-combined signals, standard hybrid combiners can fit in with around 3 dB insertion loss. It goes without saying: sacrificing half of the power is an RF design crime!

On the other hand, low-loss same-band combiners can be thought of as customized diplexers—designed and built around the operator’s exact start and stop frequencies for their intended sub-band combinations. They usually exhibit insertion losses in the range of 0.5 dB. As the available separating guard band gets smaller, the filters complexity, size and cost get higher to achieve the same insertion loss.

## Filtered antennas

We are more frequently witnessing low bands becoming available in different markets, like the APAC band 28 (700 MHz), Europe band 20 (800 MHz) and U.S. band 71 (600 MHz). Consequently, the need for more low-band ports is on the rise. The problem with adding more low-band side-by-side arrays is always the size and wind load implication, due to the relatively bigger wavelengths.

Figure 11 shows a construction comparison between an antenna with side-by-side twin low-band arrays and another using low-loss diplexers (DPX)—commonly known as filtered antennas. Deploying low-loss diplexer filters just before the radiating elements gives the flexibility in separately adjusting electrical tilts for each input band. However, as the low-loss diplexers are tuned for specific frequencies with some guard bands in between, each input port is specific to certain bands as shown in Figure 11. This adds limitations when it comes to 4x4 MIMO activation, as compared to traditional side-by-side array construction.

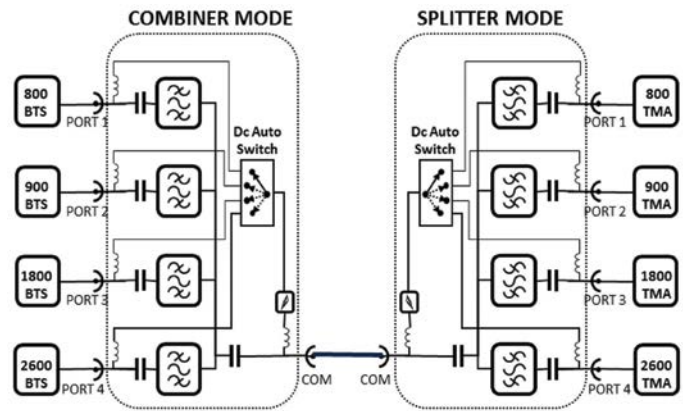

Figure 9: A CommScope multiband combiner with dc smart bypass—block diagram



Figure 10: A CommScope twin penta-plexer and LLC900 MHz

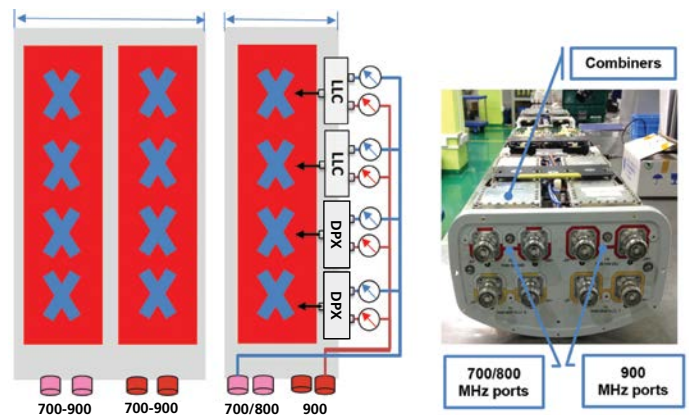

Figure 11: Side-by-side twin array and CommScope filtered antenna



# First domain: densification

## 6 | Heterogeneous networks

### 6.1 Outdoor small cells

Using outdoor small cells is another sensible densification approach. I always say that the best thing about small cells is their ability to address capacity issues at the exact problematic hotspot location.

But how small is a small cell? This is usually classified by the cell's capacity (base-band processing), TX power (range) and antenna height. Table 1 below shows some further classifications and common terminologies in the industry.

Despite their advantages, small cells face tremendous difficulties to deploy, such as in power supply, link, concealment and interferences from macros—especially in UMTS.

#### Macro to micro interference mitigation

It's no secret that most operators around the globe are always short in spectrum. This might force small cell deployments over an existing shared macro carrier. As traditional small cells, omni antennas do not support electrical tilting—their signals tend to travel long distances. Eventually, we end up with bad SINR performance at the cell edges.

To address this problem, CommScope has designed an omni antenna with electrical tilt capabilities. We call it the quasi omni antenna.

The concept is very simple. As can be seen from Figure 12, it has three directional panel antennas arranged in a triangular prism-like form. These are fed by a single input passing through a built-in three-way splitter. That's where the name "quasi omni" originates. Note that the directional panels' gain compensate for splitter losses, at their 3-beam peak directions. However, the antenna size gets bigger than traditional omni stick antennas.

#### Concealment solutions

We are usually obliged to hide small cells from the eyes of the public—either for municipalities' restrictions, public health concerns or vandalism and theft.

CommScope has a number of innovative solutions that were developed with and for operators. For example, Figure 13 shows a solution developed for phone booth installations. Another for lamp posts and so on.

When it comes to concealment, there is no "one size fits all" solution. On the contrary, it is highly dependent on operators' infrastructures and surrounding cities' nature.

	Capacity (users)	TX power
Femto	<32	20–24 dBm
Pico	32–128	24–30 dBm
Micro/metro	128–256	30–37 dBm

Table 1: Small cell classes



Figure 12: A CommScope quasi omni



Figure 13: CommScope concealment solutions

# Second domain: efficiency

Now let's move on to the second capacity domain: efficiency. Here we discuss three topics:

- Spectral efficiency
- Cost efficiency
- Deployment efficiency

## 7 | Spectral efficiency

Spectral efficiency is usually expressed in Mbps per Hertz—in other words, how much throughput we can squeeze in each available Hertz of spectrum.

Figure 14 shows us how technology evolution has a big say when it comes to spectral efficiencies. In fact, networks' continuous modernization and upgrading to the latest features is crucial in maximizing capacities.

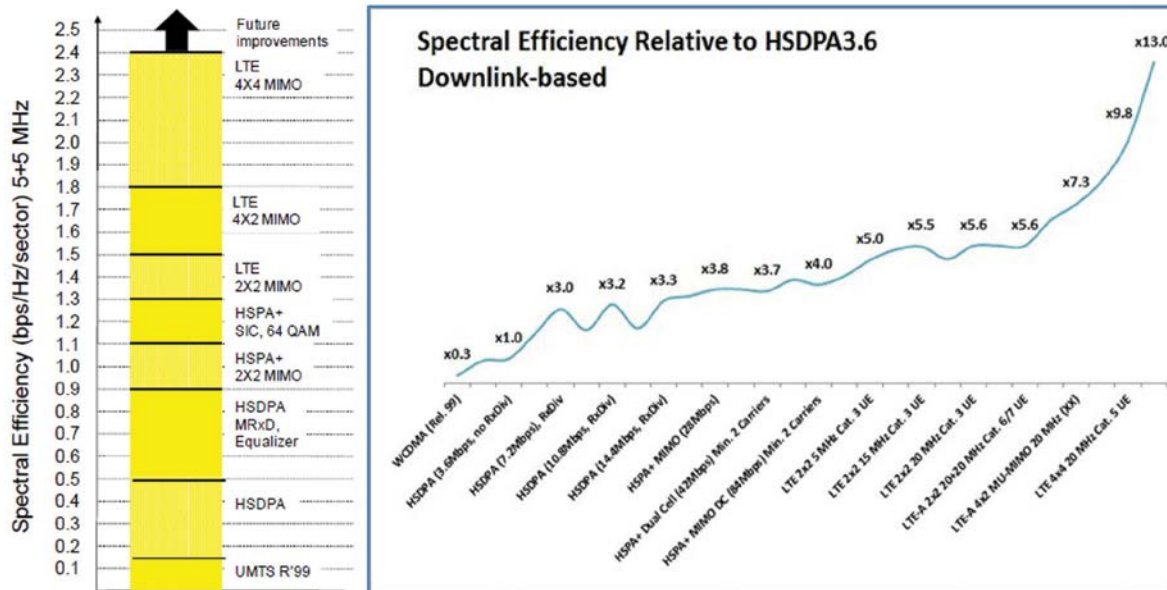

Figure 14: Evolution of spectral efficiency<sup>iii</sup>

### 7.1 High-performance base station antennas

The concept of high-performance antennas is relatively new. Historically speaking, back in the 1990s, cellular bands were few, with a small span. Looking at the GSM 900 MHz band, we had just 2x 80 MHz of bandwidth. Today, it is very common to see antennas spanning the 1800 to 2600 MHz bands—10 times wider.

But where is the problem in that? Well, panel antennas are composed of radiating antenna elements whose dimensions and separations are designed for certain wavelengths. Having such big frequency spans results in irregular radiating patterns—sometimes not even close to what is specified in datasheets.

Let's look into one of the most important antenna parameters: the H-HPBW (horizontal half-power beamwidth). Most deployments are planned for 65° HPBW, which is what we commonly see listed in datasheets, but is that really how the pattern looks across the full supported bands? According to Figure 15, this is not the case with all manufacturers. The figure plots H-HPBW versus frequency for three manufacturers. Each curve on the chart, in a different color, represents an electrical tilt setting. It is obvious that the intended 65° HPBW changes with frequency and electrical tilt. In the case of the Supplier A plots, it shrinks to 50°—expanding to 75° in some cases.

# Second domain: efficiency

That is a serious problem and results in coverage gaps or overlap interferences. The worst part is that your fellow optimizers will never expect the antenna to have such bizarre behavior. Not to mention the subsequent loss in capacity. To avoid such problems, it is advisable to select high-performance base station antennas during the planning phases. Mis-selection problems can be avoided if standard BASTA datasheets are used. These list antenna parameters across predefined sub-bands and electrical tilt settings, for fairer comparison.

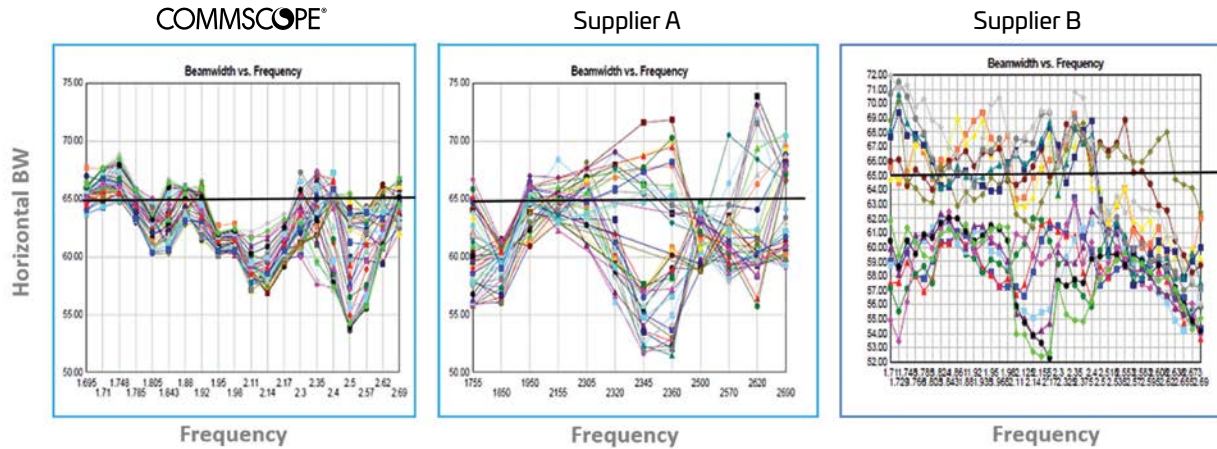

Figure 15: H-HPBW comparison

## 7.2 Tower mounted amplifiers (TMAs)

It is well known that handheld devices (UEs) have much lower transmit power (usually <1 watt) compared to base stations. With sites running long feeders between the BTS cabinet and antennas, the UE's signal gets further attenuated—maybe getting below the receiver's sensitivity and going unnoticed. Imagine subscribers on the cell edge, seeing sufficient coverage bars on their handsets but always failing to set up or receive a call—generating tons of complaints. A TMA is designed to overcome such problems.

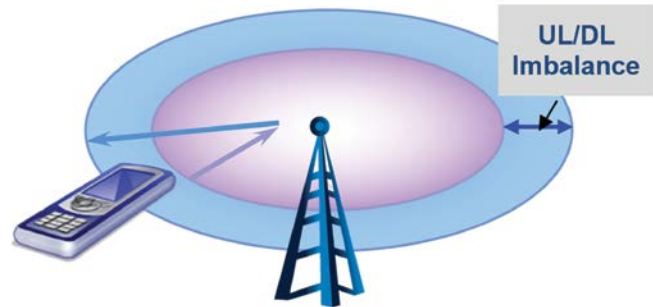

Figure 16: Link imbalance

### Noise figure

A receiver's noise factor, as its name implies, is the noise added by the receiver itself—in other words, the receiver's ratio of input SNR to output SNR. Now, in the UL path, a TMA amplifier followed by a BTS amplifier creates a cascaded receiver's noise factor. This can be expressed by the following simplified Friis formula

$$F_{Receiver} = F_{TMA} + F_{BTS} / G_{TMA} - 1 / G_{TMA}$$

Where F is the noise factor and G is the amplifier's gain.

Thus, the noise factor of the first amplification stage  $F_{TMA}$  has the biggest weight. While the higher the TMA's gain, the lower the resulting effect of the BTS noise. Consequently, adding a TMA with low noise factor and higher gain improves the overall noise figures.

Cable loss	Receiver NF		Difference
(dB)	No TMA (dB)	With TMA (dB)	(dB)
0	4.5	1.84	2.66
1	5.5	1.97	3.53
2	6.6	2.13	4.37
3	7.5	2.32	5.18
4	8.5	2.54	5.96
5	9.5	2.81	6.69
6	10.5	3.13	7.37

Table 2: TMA and noise figures

Table 2 shows how a TMA improves the receiver's overall noise figure (NF). Note that an NF is the noise factor expressed in decibels and that TMAs make bigger impacts with longer cables.

# Second domain: efficiency

## TMA portfolio

There have recently been different flavors in the portfolios of TMAs, which can span across both FDD and TDD technologies. However, as multiple frequency bands become available along with requirements for higher order MIMO with 4x2 and 4x4 configurations, CommScope developed a full suite of multiband TMAs to further reduce the total tower loading and number of boxes on towers.

- **Singleband TMAs:** Among the most common and widely used TMAs are singleband TMAs. These support different standard 3GPP bands or customized sub-bands, including RF bypass.
- **Dualband TMAs:** These cover all commercial 3GPP bands, 700/850, 700/900, 850/900, 800/900, 1800/2100, 1800/2600, and 2100/2600 among others. Different versions are made with 7-16 DIN or 4.3-10 connectors.

For instance, there is a twin dualband TMA (1800/2100MHz) designed to reduce feeder runs. It has two ports toward the BTS and four ports toward the antenna with a built-in 1800/2100 diplexer. Typically, an external diplexer is used at the tower's bottom, combining 1800/2100 on a single feeder. The TMA then separates these to the respective 1800/2100 antenna ports.

- **Triband TMA:** CommScope has been a pioneer in the development of triband TMAs—especially for high bands. A single device can cover 1800/2100/2600 or 1800/2100/2300 (TDD/FDD), reducing tower wind loading and occupation. Different versions are available with 7-16 DIN and 4.3-10 connectors as well as different antenna port configurations. A triband TMA can have two input ports through the BTS and two output ports through the antenna, accommodating all three bands—1800, 2100 and 2600 MHz.

- **Quadband and pentaband TMAs:** The world's first quadband and pentaband TMA that allows integrating four or five TMAs in one device—for example, 850/900/1800/2100 or 700/850/900/1800/2100—aiming for further reductions in tower wind loading and occupation. Different versions are available, with 7-16 DIN and 4.3-10 connectors as well as different antenna port configurations.



Figure 17: A CommScope TMA1800/2100 example



Figure 18: CommScope triband TMA1800/2100/2600



Figure 19: CommScope quadband and pentaband TMAs

# Second domain: efficiency

## 8 | Cost efficiency

### 8.1 PowerShift

As the industry evolves to LTE-Advanced, with more bands and higher MIMO schemes, it is very common to add more remote radio units (RRUs) to working sites. Have you ever come across situations where dc power cables' diameters are not thick enough for the extra current? Most people have—and they usually pull extra power cables, whether on towers or for indoor IBS. But there is another way.

#### Theory

As  $\text{Power (W)} = \text{Voltage (V)} \times \text{Current (I)}$ .

For the same power requirements, increasing voltage reduces the current—and less current means thinner power cables. This is exactly what the PowerShift does.

#### Function

PowerShift works by maintaining the optimum voltage at the RRU, compensating for the voltage drop in copper power lines.

As can be seen in Figure 20, a single 19" shelf (base unit) holds up to four plug-and-play modules. Each module has dc input and output for three RRUs, with maximum 1200 watts of power.

#### How it works

The PowerShift base unit will not operate without adding a capacitive jumper across the target RRU power terminals, as in Figure 21.

The concept is simple yet genius. We all know, from the old school days, how capacitors pass ac and block dc currents. From here, our PowerShift injects small ac currents at first, which return through the added capacitive jumper, and then measures the power line's voltage drop. It then compensates for that drop while powering up the RRU with the dc voltage.

#### Benefits

- Reutilizing existing copper supply lines. No need to install larger or additional copper wires for higher wattage radios.
- Battery back-up time increase. Gets entire battery backup time to the RRUs by eliminating the voltage drop in the power supply cable.



Figure 20: A PowerShift base unit

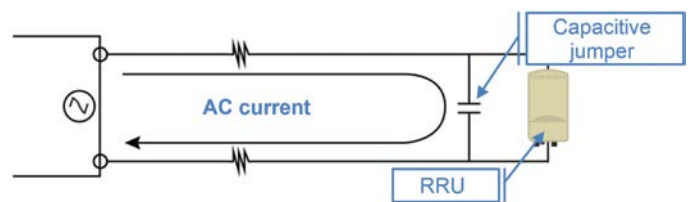

Figure 21: PowerShift diagram

# Second domain: efficiency

## 8.2 Site and antenna sharing

The major driver of network sharing continues to be the potential for cost efficiency. The amount an operator can save depends upon the depth of the sharing arrangement.<sup>iv</sup>

There are three main sharing categories:

- Passive: Towers, power supply, shelters, etc.
- Active: Base stations, backhaul, controllers, core network, antennas
- Roaming based: Virtual operators (MVNO), national roaming

A shared site can also be owned by:

- Single operator, adding new technology to an existing site
- Multiple operators, sharing CapEx/OpEx
- Tower companies, renting tower space and power to operators.

### Forced antenna sharing

Generally, on sites with space limitations or health and safety regulations, operators are forced to share the same antenna. Alternatively, to reduce power usage, emissions and aesthetic impact, many countries like Brazil, Canada and Jordan are stipulating that operators seeking to deploy new services must be willing to share passive and/or active elements within the networks, including antennas. There are two basic solutions to antenna sharing: using multiport antennas or deploying low-loss combiners.

Today's multiport antennas provide an excellent opportunity for MNOs to take advantage of antenna sharing while retaining control of their individual antenna elements and coverage patterns. Current multiport antennas can support multi-operator RET controllers, feature low-loss RF performance, and enable mobile operators to change their frequency band allocation without physically modifying the antenna.

The biggest challenge when deploying multiport antennas in support of a shared network is the larger physical size of the antenna and the resulting increase in tower loading. This is especially problematic across multiple ports in the lower frequency bands, where the antenna array is larger to begin with.

Or MNOs can deploy low-loss combiners (LLC), as explained in 5.2, in place of multiport antennas. This reduces the number of antenna arrays required and enables the operator to minimize the antenna size and tower loading. This type of solution is often used to deploy an LTE overlay onto a network's legacy services. However, it, too, has drawbacks. Operators give up independent

RET control and, unless PIM-certified products are used, they risk higher incidences of passive intermodulation (PIM), VSWR and RF path loss. While either multiport antennas or low-loss combiners can be used to enable antenna sharing, the best solution may be a combination of both. Using low PIM-rated low-loss combiners for the low bands and a multi-port antenna for the high bands takes advantage of the strengths of both technologies while minimizing the weaknesses.

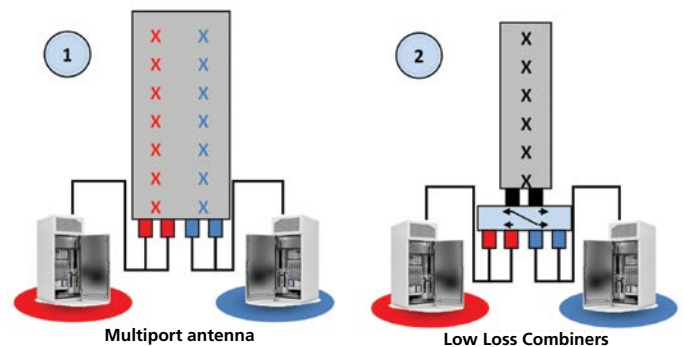

Figure 22: Antenna sharing scenarios

# Second domain: efficiency

## 9 | Deployment efficiency

### 9.1 HELIAX® FiberFeed® hybrid cables

There is no question how remote radio units (RRU) have eliminated long RF cables losses and the need for TMAs. However, one of the challenges we face with RRU deployments is their complicated optical fiber and power cabling. Figure 23 shows how messy some installations can get. This undoubtedly increases failure rates and makes it harder to troubleshoot problems. CommScope's HELIAX FiberFeed hybrid solutions are designed to solve such challenges.

These hybrid solutions combine copper power wires and optical fibers inside a single armored cable. The configuration is customizable and the armor ensures reliability—especially over shared or rented infrastructures.

Figure 24 further illustrates the components used in the HELIAX FiberFeed hybrid solutions. The Pendant, shown here as the breakout terminal, is the latest innovative member to the HELIAX FiberFeed portfolio. The Pendant hybrid solution allows direct RRU fiber and power connectivity from standard sockets.

An independent engineering firm has been invoked to measure the installation efficiency improvement between HELIAX FiberFeed hybrid solutions and traditional discrete cables. For a 6RRU/30-meter tower installation, the time was 1'49" and 4'46" respectively, which is more than 2.5 times as fast as with hybrid installations.

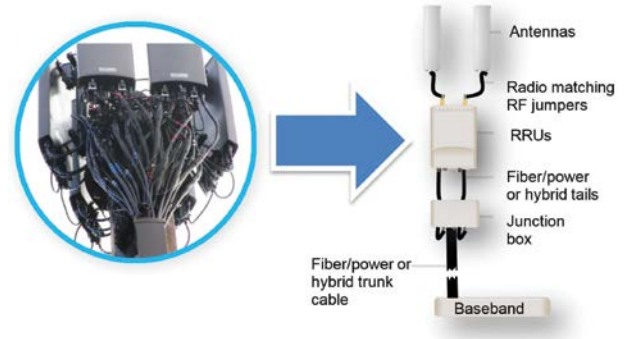

Figure 23: HELIAX FiberFeed hybrid advantage

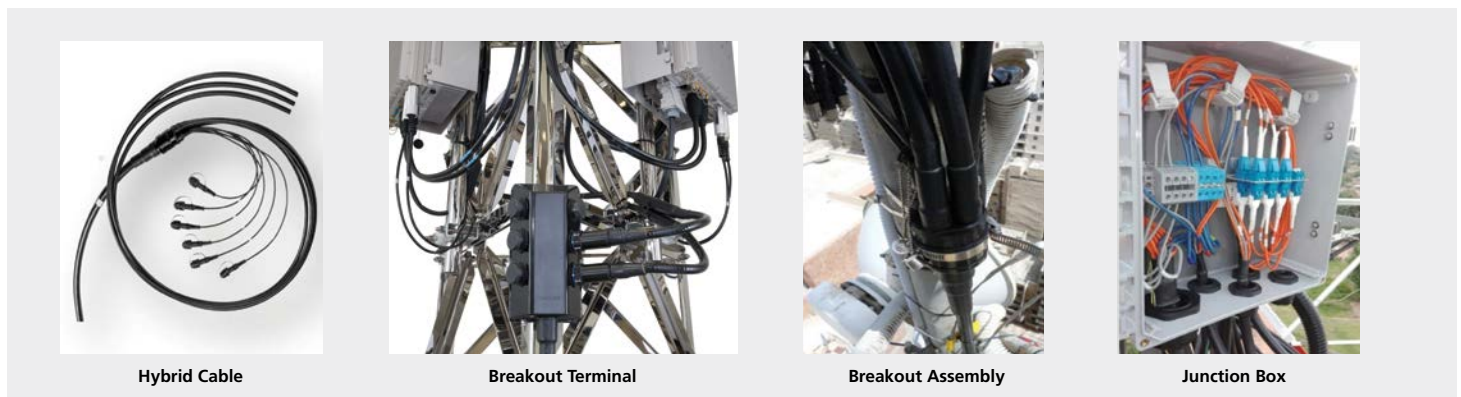

Figure 24: HELIAX FiberFeed hybrid solution building blocks

# Third domain: spectrum

Spectrum is the scarcest and most valuable resource in the wireless industry. When it comes to mobile network operators, every single Hertz is needed and worth fighting for.

In this last, but certainly not least, capacity domain, we'll take a deeper look into:

- **Mobile bands and spectrum allocation regulations**
- **IMF filters**
- **Passive intermodulation**

## 10 | Mobile bands and spectrum allocation regulations

### 10.1 The ITU

The International Telecommunications Union (ITU) is the United Nations specialized agency for information and communication technologies. Here is their mission statement: "We allocate global radio spectrum and satellite orbits, develop the technical standards that ensure networks and technologies seamlessly interconnect, and strive to improve access to ICTs to underserved communities worldwide."



Figure 25: ITU regions

Per Figure 25, The ITU divides the globe into three regions, with regional offices in Addis Ababa (for Africa), Bangkok (for Asia and Pacific), Brasilia (for the Americas), Cairo (for the Arab States), a Europe Coordination Office at ITU Headquarters and Moscow (for the CIS countries).

On the other hand, we see countries' Telecom Regulatory Authorities, such as the FCC in the United States, also having their own regional assemblies. This is where they discuss their regional spectral needs. So we have the CEPT in Europe, ATU in Africa, ASMG in the Middle East, CITEL in the Americas, and APT in Asia.

### 10.2 The WRC

But what's of most concern to us here is how spectrum is being allocated to mobile networks. Typically, the ITU arranges its World Radio Conference (WRC) every 3–4 years.

The WRC reviews and revises radio regulations, International treaties governing the use of the radio-frequency spectrum, geostationary-satellite and non-geostationary-satellite orbits.

During the latest WRC-15 (November 2015), a number of new bands were re-allocated to the mobile industry:

- C-band (3.4–3.6 GHz)
- L-band (1427–1518 MHz)
- 700-band (694–790 MHz)

The upcoming WRC-19 is expected to decide on spectrum bands above 24 GHz for 5G services.



### 10.3. Ultra-wideband antennas

With respect to such developments, ultra-wideband antennas were developed that can cover a wider spectrum allocation. Below are some examples that span more than 266 MHz on the low band and 1086 MHz on the high band.



- 1 x 65°, **694-862** MHz
- 2 x 65°, **880-960** MHz
- 2 x 65°, **1695-2690** MHz
- Gain: 16.7/18.4 dBi
- E-tilt: 2-12°/2-12°
- \* 1 x 65°, **694-960** MHz
- \* 1 x 65°, **1427-1518** MHz
- \* 2 x 65°, **1695-2690** MHz
- \* Gain: 14.9-18.2 dBi
- \* E-tilt: 2-14° / 2-12°

Figure 26: Ultra-wideband antenna examples



# Third domain: spectrum

## 11 | IMF filters

Are you a movie fan? If you are, then you must have probably thought IMF stands for the Impossible Mission Force, led by Ethan Hunt in the Mission Impossible movie series. Yet, at CommScope, we had another impossible mission to take over: removing in-band interference. For this reason, we've designed interference mitigation filters. But, of course, "As always, should you or any of your I.M. Force be caught or killed, the Secretary will disavow any knowledge of your actions. This message will self-destruct in five seconds. Good luck!"

### 11.1 The leakage problem

It might happen that your local regulator didn't do a very good job with his spectrum allocation plan—and your uplink channels are adjacent to another high-power DL transmitter.

Figure 27 shows a real-life example where a CDMA DL channel was adjacent to a victim WCDMA UL one. Due to cost and size implications, neither the transmitter nor receivers, in base stations, have sharp enough filters. This results in the shown overlapping area that passes co-channel interference to the receiver and saturates its reception.

The resulting adjacent channel interference ratio (ACIR) is the ratio of the total power transmitted from a source to the total interference power affecting a victim receiver, resulting from both transmitter and receiver imperfections. It has, thus, two contributors:

- Transmitter out of band emission (OOBE) or adjacent channel leakage power ratio (ACLR)
- Receiver selectivity or adjacent channel selectivity (ACS)

And is expressed as  $ACIR = \frac{1}{\frac{1}{ACLR} + \frac{1}{ACS}}$

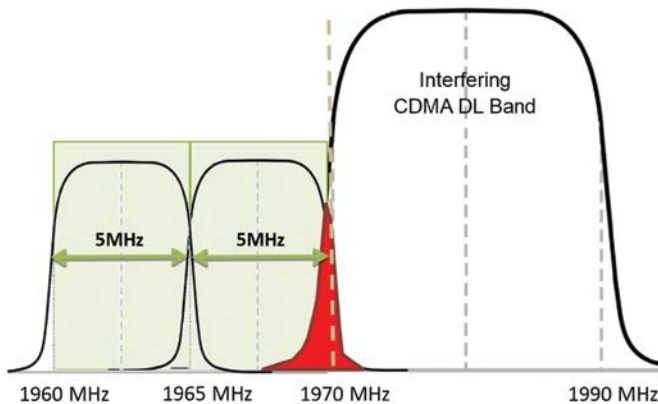

Figure 27: Adjacent interference

### 11.2 The IMF solution

In most cases, the offenders do not react to clean up their own mess, leaving the victims—which might be you—looking for solutions. Luckily there is one: the IMF. IMF solutions include both fully customized designs as well as a complete line of existing solutions that can be adapted for specific needs. IMF technology can be incorporated into a variety of filter types and designs, including ceramic, cavity, stripline, crystal, SAW, tubular and adjustable filters. The resulting solutions can

then be deployed as standalone filters or integrated into tower-mounted amplifiers (TMAs) and combiners.

In the example shown in Figure 29, The IMF filter response (shown as a blue line) significantly removes the majority of the interfering overlapping area.



Figure 28: A CommScope IMF

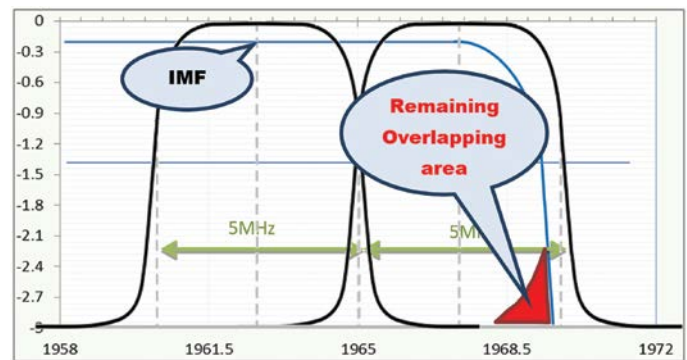

Figure 29: IMF effect

# Third domain: spectrum

## 12 | Passive intermodulation—PIM

### 12.1. PIM basics

#### Linearity and nonlinearity

Linear systems exhibit linear relations between their input and output signals. When it comes to active devices, like amplifiers, nonlinearity is expected and measured as part of its frequency response curves. On the other hand, passive devices like connectors and cables are assumed to behave linearly, showing a uniform response across supported bands. Unfortunately, that's partially true. Passive RF components can also unexpectedly produce nonlinear distortion, mainly due to:<sup>v</sup>

- Improper connector attachment
- Poorly torqued connections with incorrect contact pressure
- Contamination or corrosion of conducting surfaces
- Inadequate plating on rust-prone ferromagnetic components
- Poor connections due to cold solder joints

#### IMD and THD

Fourier series show us how signals in time domain can be decomposed to combinations of pure sine and cosine waves in the frequency domain. Assuming a pure sine wave that deforms after passing through a nonlinear system, as in Figure 30, the deformation can be expressed in additional “harmonics” being added to the output signal. These harmonics are integer multiplications of the input carrier. Their effect is referred to by the term total harmonic distortion (THD).

Passing two or more carriers results in inter-modulation distortion (IMD). It results from adding and subtracting input carriers with different weights. The IMD order is the modulus sum of these weights.

For example, let's assume three input carriers—F1, F2 and F3. Third-order IMD can be any combination of the following carriers and multiplied weights that add up to three.

$1F_1 - 2F_2$ , or  $2F_1 - 1F_2$ , or  $1F_1 + 1F_2 - 1F_3$ , or  $1F_1 + 1F_2 + 1F_3$ , ...etc. Similarly, 5th- and 7th-order IMD can be calculated.

From here, the name passive intermodulation (PIM) originates from a passive nonlinear RF path, with two or more carriers passing through, resulting in intermodulation (IMD).

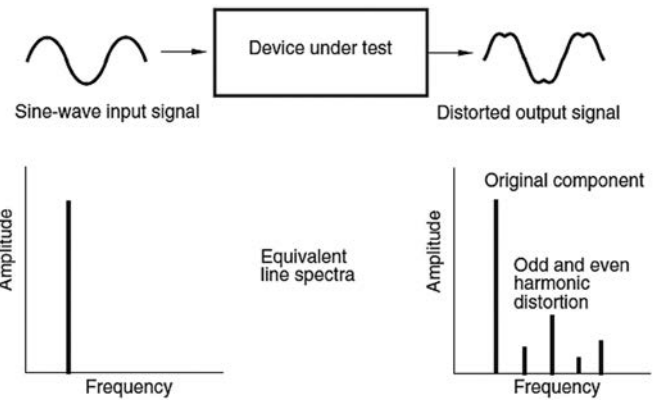

Figure 30: Harmonic distortion<sup>vi</sup>

#### The PIM risk

So why are we so concerned with PIM? Well, it happens that resulting downlink IMD combinations of frequencies might fall into one of the operational uplink bands. This, for sure, will raise the UL noise floor and might even saturate the receiver—causing significant losses in UL throughputs and performance.

It has been shown that, the higher the IMD order, the lower the amplitude gets with a wider bandwidth. Hence we are mostly concerned with IMD3.

It is also worth mentioning that, with LTE operating on resource block subcarriers (180 KHz bandwidths)—and with its wide support of various spectral bands—the possibility of PIM hits is expanding more than ever before.

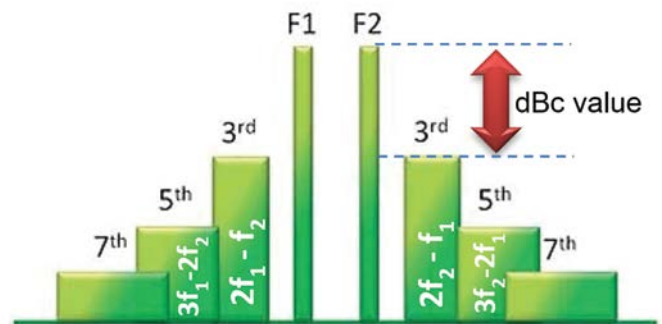

Figure 31: IMD and PIM order<sup>vii</sup>

# Third domain: spectrum

## 12.2. Measuring PIM

### Standards

IEC 62037 is the international standard for measuring passive RF and microwave device PIM. The document specifies injecting two continuous wave test signals, to the device under test (DUT). As PIM is generated from the DUT itself, the resulting IMD will propagate in both reverse and forward directions. It can hence be measured in either direction, as shown in Figure 32.

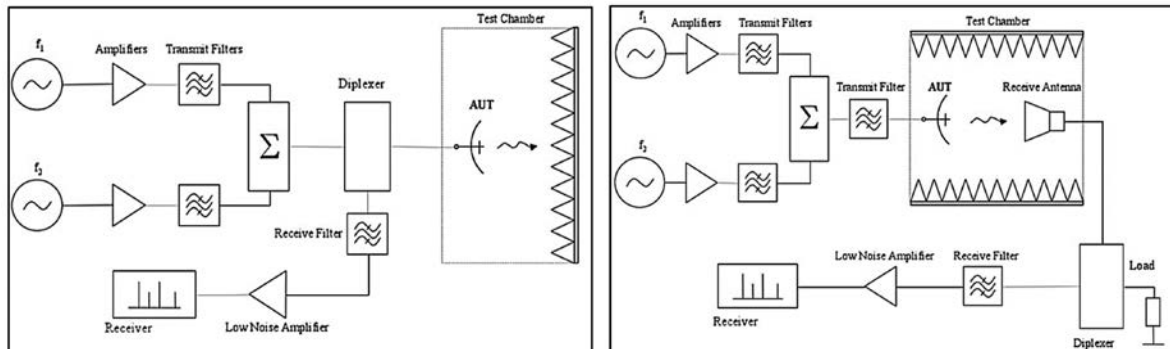

Figure 32: IEC 62037 reverse and forward PIM measuring<sup>viii</sup>

### PIM test precautions

On the left side of Figure 32 there is a reverse test scenario for a base station antenna—the most common type in field measurements. Because PIM levels are extremely sensitive to test equipment and surroundings, ideally, the antenna (DUT) is placed in a test chamber away from external affecting objects or signals.

However, test chambers are not possible in field tests; thus, special precautions are needed to improve testing accuracy. A complete CommScope PIM measurements guide can be found the [PIM white paper](#)<sup>ix</sup>. In summary, field testing should be conducted on a clear day and away from other equipment. Forklifts, people with cell phones, metal objects, fences, site equipment—even the weather—can impact the test results.<sup>ix</sup>

### Measuring units and acceptable limits

PIM is expressed in decibels relative to carrier, or dBc. This is the measured PIM level relative to the injected signal power as shown in Figure 31. The industry standard is <-150 dBc with 20-watt input test signals, but this value slightly differs between operators.

Measured dBm can be easily converted to dBc and vice versa using the following simple formula:

$$\text{PIM (dBc)} = \text{PIM (dBm)} - \text{Test signal (dBm)}$$

For example, a measured -120 dBm PIM level from 2x20W (43 dBm) test signals

$$\begin{aligned} \text{PIM (dBc)} &= -120\text{dBm} - 43\text{dBm} \\ &= -163\text{dBc} \end{aligned}$$

# Third domain: spectrum

## Test signals power

Although the IEC standard recommends 20 watts for the input test signals, there has been a debate in the industry around whether that needs to be increased to match modern radios' powers.

As PIM field test equipment is mobile, it is desirable to be small, light and battery operated. Increasing test signal powers obviously reflects on bulkier equipment and shorter battery lifetimes.

In theory, IM3 is expected to change 3 dB for every 1 dB change in test power. Assuming linearity, values can be extrapolated for higher radio powers. So 20-watt or lower test signals should be fine as long as the cable attenuation is not violating the receiver's sensitivity levels.

On the other hand, each test device has its own internal PIM that is added or subtracted to the DUT readings (blue and red curves, respectively, in Figure 33). The IEC standard specifies that such "self-PIM" is to be at least 10 dB less than the measured DUT readings. From Figure 33, as this difference increases to 20 dB (X-axis), the error margin decreases to  $\pm 1$  dB (Y-axis)—eventually improving the accuracy of the tests.

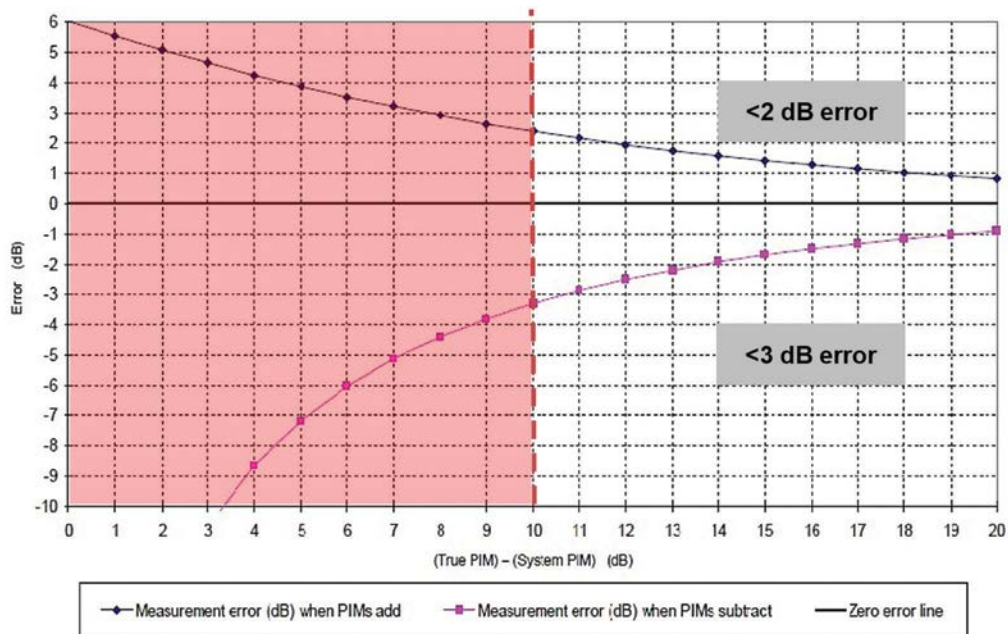

Figure 33: IEC 62037 internal PIM effect

## Fixed or sweeping test signals

The IEC standard specifies two equal-power continuous wave (CW) test signals. But should these test signals sweep the entire frequency band under test or remain fixed? In fact, there are pros and cons to each approach.

### Fixed test carriers

One problem that can be met is that UL bands are never free from surrounding UE devices' transmissions—potentially impacting DUT PIM readings. If we fix the F1 and F2 test carriers' frequencies, we can select F1 and F2 such that their 3rd-order IMD (2F1-F2, 2F2-F1) falls in the guard band or duplex gap band, where no UEs are transmitting.

### Sweeping test carriers

Fixed test carriers also have their limitations. Out-of-phase PIM signals can cancel each other, leaving undetected PIM problems. Sweeping one of the test signals' frequency will avoid such a problem—enhancing the test's accuracy.



## Third domain: spectrum

With networks' complexity continuously on the rise—demanding higher bands and tighter PIM tolerances—a new generation of connectors has evolved. The 4.3-10 connectors are characterized by smaller size (4.3 and 10 millimeters) and better PIM performance. Here is why:

As explained on Figure 35, the 7-16 DIN connector electrical contacts are dependent on the mechanical screwing extent. This requires using torque wrenches, typically set at 30 Nm, to ensure electrical contacts are in place. This is in contrast to the 4.3-10. It is designed to separate its mechanical locking mechanism from electrical contacts, reducing torque to around 5 Nm. With the majority of installations performed without torque wrenches, the possibility of PIM generation increases. The 4.3-10 helps solve that problem.

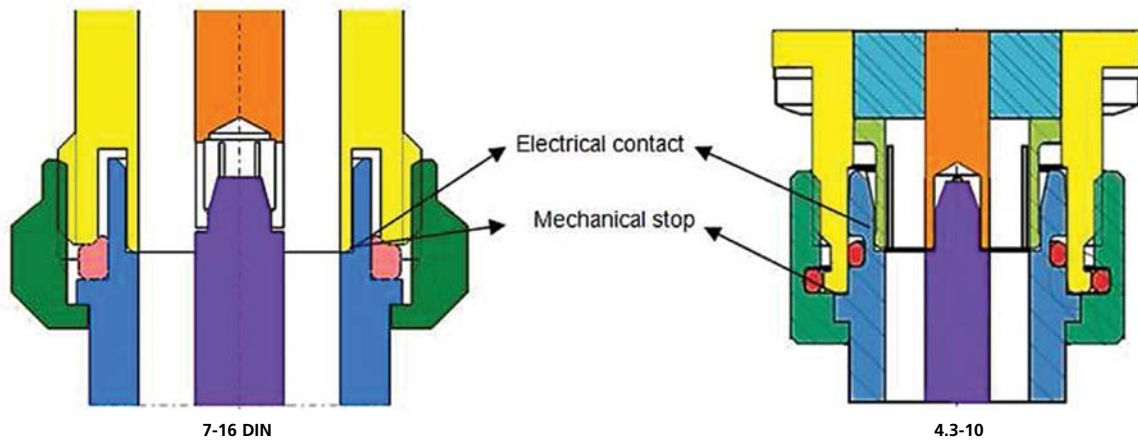

Figure 35: Connector cross sections<sup>x</sup>

As for the ease of installation, besides being smaller in size, this connector also comes in three different versions: traditional screw-on, hand screw, and push-pull (quick lock).

### ***D-class jumpers***

Tower vibration, varying component installation techniques, and changing weather can all cause PIM that adversely affects site component performance, even though they have already passed static PIM tests. The International Electro-technical Commission (IEC) developed a series of five tests to measure PIM caused by dynamic factors such as flexing, tapping or pulling—duplicating the effects of adverse weather conditions at the top of a tower.

CommScope SureFlex<sup>®</sup> D-class jumpers are individually tested under these dynamic conditions. Test results are also accessible online over the CommScope WebTrak and C-Trak smartphone app.

Figure 36: D-class jumpers



## References

- <sup>i</sup> <http://www.cisco.com/c/en/us/solutions/service-provider/visual-networking-index-vni/index.html>
- <sup>ii</sup> <https://www.ericsson.com/mobility-report>
- <sup>iii</sup> <https://techneconomyblog.com/tag/spectral-efficiency/>
- <sup>iv</sup> Mohamed Nadder, CommScope white paper, Sharing an antenna doesn't mean giving up control, November 2015
- <sup>v</sup> CommScope e-book, Understanding the RF path
- <sup>vi</sup> Francis Rumsey; Tim McCormick. Sound and Recording: An Introduction (6th ed.). Focal Press
- <sup>vii</sup> <https://www.anritsu.com/en-IN/test-measurement/technologies/pim>
- <sup>viii</sup> IEC 62037, Passive RF and Microwave Devices, Intermodulation Level Measurement
- <sup>ix</sup> Ray Butler, PIM Testing, CommScope white paper
- <sup>x</sup> NGMN Alliance, 4.3-10 RF Connector Migration Strategies, June 2016

**COMMScope**<sup>®</sup>

---

commscope.com

Visit our website or contact your local CommScope representative for more information.

© 2018 CommScope, Inc. All rights reserved.

Unless otherwise noted, all trademarks identified by ® or ™ are registered trademarks, respectively, of CommScope, Inc. This document is for planning purposes only and is not intended to modify or supplement any specifications or warranties relating to CommScope products or services. CommScope is committed to the highest standards of business integrity and environmental sustainability with a number of CommScope's facilities across the globe certified in accordance with international standards, including ISO 9001, TL 9000, and ISO 14001. Further information regarding CommScope's commitment can be found at [www.commscope.com/About-Us/Corporate-Responsibility-and-Sustainability](http://www.commscope.com/About-Us/Corporate-Responsibility-and-Sustainability).